



# **OFFICIAL SITTING VOLLEYBALL RULES**

## **2025 – 2028**

Approved by the World ParaVolley Board of Directors



Official Sitting Volleyball Rules 2025 – 2028 (v1 2025-02-24)

Published by World ParaVolley in 2025 – [www.worldparavolley.org](http://www.worldparavolley.org)

Illustrations: © World ParaVolley 2025



# OFFICIAL SITTING VOLLEYBALL RULES

## 2025 – 2028

Approved by the World ParaVolley Board of Directors

To be implemented in all World, International, National, and League Competitions beginning after 1<sup>st</sup>  
February 2025

# CONTENTS

<b>GAME CHARACTERISTICS .....</b>	<b>9</b>
<b>PART 1: PHILOSOPHY OF RULES AND REFEREEING .....</b>	<b>10</b>
INTRODUCTION .....	11
THE RULES TEXT .....	11
THE REFEREE WITHIN THIS FRAMEWORK.....	11
<b>PART 2, SECTION 1: RULES OF THE GAME .....</b>	<b>13</b>
<b>CHAPTER 1: FACILITIES AND EQUIPMENT.....</b>	<b>14</b>
<b>RULE 1: PLAYING AREA .....</b>	<b>14</b>
1.1 DIMENSIONS .....	14
1.2 PLAYING SURFACE .....	14
1.3 LINES ON THE COURT .....	14
1.4 ZONES AND AREAS .....	15
1.5 TEMPERATURE .....	16
1.6 LIGHTING .....	16
<b>RULE 2: NET AND POSTS.....</b>	<b>16</b>
2.1 HEIGHT OF THE NET .....	16
2.2 STRUCTURE.....	16
2.3 SIDE BANDS .....	16
2.4 ANTENNAE.....	17
2.5 POSTS .....	17
2.6 ADDITIONAL EQUIPMENT .....	17
<b>RULE 3: BALLS .....</b>	<b>17</b>
3.1 STANDARDS.....	17
3.2 UNIFORMITY OF BALLS.....	17
3.3 FIVE-BALL SYSTEM .....	17
<b>CHAPTER 2: PARTICIPANTS .....</b>	<b>19</b>
<b>RULE 4: TEAMS.....</b>	<b>19</b>
4.1 TEAM COMPOSITION .....	19
4.2 LOCATION OF THE TEAM.....	19
4.3 EQUIPMENT.....	19

4.4 CHANGE OF EQUIPMENT.....	20
4.5 FORBIDDEN OBJECTS.....	20
<b>RULE 5: TEAM LEADERS.....</b>	<b>21</b>
5.1 CAPTAIN .....	21
5.2 COACH .....	21
5.3 ASSISTANT COACH.....	22
<b>CHAPTER 3: PLAYING FORMAT.....</b>	<b>23</b>
<b>RULE 6: TO SCORE A POINT, TO WIN A SET AND THE MATCH.....</b>	<b>23</b>
6.1 TO SCORE A POINT .....	23
6.2 TO WIN A SET .....	23
6.3 TO WIN THE MATCH.....	23
6.4 DEFAULT AND INCOMPLETE TEAM .....	23
<b>RULE 7: STRUCTURE OF PLAY .....</b>	<b>24</b>
7.1 THE TOSS .....	24
7.2 OFFICIAL WARM-UP SESSION.....	24
7.3 TEAM STARTING LINE-UP .....	24
7.4 POSITIONS .....	25
7.5 POSITIONAL FAULT .....	26
7.6 ROTATION.....	26
7.7 ROTATIONAL FAULT .....	26
<b>CHAPTER 4: PLAYING ACTIONS .....</b>	<b>27</b>
<b>RULE 8: STATES OF PLAY .....</b>	<b>27</b>
8.1 BALL IN PLAY.....	27
8.2 BALL OUT OF PLAY.....	27
8.3 BALL “IN” .....	27
8.4 BALL “OUT” .....	27
<b>RULE 9: PLAYING THE BALL .....</b>	<b>27</b>
9.1 TEAM HITS .....	27
9.2 CHARACTERISTICS OF THE HIT.....	28
9.3 FAULTS IN PLAYING THE BALL .....	28
9.4 CONTACT WITH THE COURT .....	28
<b>RULE 10: BALL AT THE NET .....</b>	<b>29</b>
10.1 BALL CROSSING THE NET.....	29

10.2 BALL TOUCHING THE NET.....	29
10.3 BALL IN THE NET.....	29
<b>RULE 11: PLAYER AT THE NET.....</b>	<b>30</b>
11.1 REACHING BEYOND THE NET .....	30
11.2 PENETRATION UNDER THE NET.....	30
11.3 CONTACT WITH THE NET.....	30
11.4 PLAYER’S FAULTS AT THE NET .....	30
<b>RULE 12: SERVICE.....</b>	<b>31</b>
12.1 FIRST SERVICE IN A SET.....	31
12.2 SERVICE ORDER .....	31
12.3 AUTHORIZATION OF THE SERVICE.....	31
12.4 EXECUTION OF THE SERVICE .....	31
12.5 SCREENING .....	32
12.6 FAULTS MADE DURING THE SERVICE .....	32
12.7 SERVING FAULTS AND POSITIONAL FAULTS.....	32
<b>RULE 13: ATTACK HIT .....</b>	<b>33</b>
13.1 CHARACTERISTICS OF THE ATTACK HIT .....	33
13.2 RESTRICTIONS OF THE ATTACK HIT .....	33
13.3 FAULTS OF THE ATTACK HIT .....	33
<b>RULE 14: BLOCK .....</b>	<b>33</b>
14.1 BLOCKING .....	33
14.2 BLOCK CONTACT.....	34
14.3 BLOCKING WITHIN THE OPPONENT’S SPACE .....	34
14.4 BLOCK AND TEAM HITS .....	34
14.5 BLOCKING THE SERVICE.....	34
14.6 BLOCKING FAULTS .....	34
<b>CHAPTER 5: INTERRUPTIONS, DELAYS AND INTERVALS.....</b>	<b>35</b>
<b>RULE 15: INTERRUPTIONS .....</b>	<b>35</b>
15.1 NUMBER OF REGULAR GAME INTERRUPTIONS .....	35
15.2 SEQUENCE OF REGULAR GAME INTERRUPTIONS .....	35
15.3 REQUESTS FOR REGULAR GAME INTERRUPTIONS .....	35
15.4 TIME-OUTS .....	35
15.5 SUBSTITUTION.....	35
15.6 LIMITATIONS OF SUBSTITUTIONS .....	36

15.7 EXCEPTIONAL SUBSTITUTION.....	36
15.8 SUBSTITUTION FOR EXPULSION OR DISQUALIFICATION.....	36
15.9 ILLEGAL SUBSTITUTION .....	36
15.10 SUBSTITUTION PROCEDURE.....	36
15.11 IMPROPER REQUESTS .....	37
<b>RULE 16: GAME DELAYS .....</b>	<b>37</b>
16.1 TYPES OF DELAY .....	37
16.2 DELAY SANCTIONS.....	38
<b>RULE 17: EXCEPTIONAL GAME INTERRUPTIONS.....</b>	<b>38</b>
17.1 INJURY / ILLNESS .....	38
17.2 EXTERNAL INTERFERENCE .....	38
17.3 PROLONGED INTERRUPTIONS.....	38
<b>RULE 18: INTERVALS AND CHANGE OF COURTS .....</b>	<b>38</b>
18.1 INTERVALS.....	39
18.2 CHANGE OF COURTS .....	39
<b>CHAPTER 6: THE LIBERO PLAYER .....</b>	<b>40</b>
<b>RULE 19: THE LIBERO PLAYER.....</b>	<b>40</b>
19.1 DESIGNATION OF THE LIBERO .....	40
19.2 EQUIPMENT.....	40
19.3 ACTIONS INVOLVING THE LIBERO .....	40
19.4 RE-DESIGNATION OF A NEW LIBERO.....	41
19.5 SUMMARY .....	42
<b>CHAPTER 7: PARTICIPANTS' CONDUCT.....</b>	<b>43</b>
<b>RULE 20: REQUIREMENTS OF CONDUCT.....</b>	<b>43</b>
20.1 SPORTSMANLIKE CONDUCT .....	43
20.2 FAIR PLAY.....	43
<b>RULE 21: MISCONDUCT AND ITS SANCTIONS .....</b>	<b>43</b>
21.1 MINOR MISCONDUCT .....	43
21.2 MISCONDUCT LEADING TO SANCTIONS.....	43
21.3 SANCTION SCALE .....	43
21.4 APPLICATION OF MISCONDUCT SANCTIONS.....	44
21.5 MISCONDUCT BEFORE AND BETWEEN SETS .....	44
21.6 SUMMARY OF MISCONDUCT AND CARDS USED.....	44

<b>PART 2, SECTION 2: PART 2, SECTION 2</b> .....	<b>46</b>
<b>CHAPTER 8: REFEREES</b> .....	<b>47</b>
<b>RULE 22: REFEREEING TEAM AND PROCEDURES</b> .....	<b>47</b>
22.1 COMPOSITION .....	47
22.2 PROCEDURES .....	47
<b>RULE 23: 1st REFEREE</b> .....	<b>48</b>
23.1 LOCATION .....	48
23.2 AUTHORITY .....	48
23.3 RESPONSIBILITIES .....	48
<b>RULE 24: 2nd REFEREE</b> .....	<b>49</b>
24.1 LOCATION .....	49
24.2 AUTHORITY .....	49
24.3 RESPONSIBILITIES .....	50
<b>RULE 25: CHALLENGE REFEREE</b> .....	<b>50</b>
25.1 LOCATION .....	51
25.2 RESPONSIBILITIES .....	51
<b>RULE 26: RESERVE REFEREE</b> .....	<b>51</b>
26.1 LOCATION .....	51
26.2 RESPONSIBILITIES .....	51
<b>RULE 27: SCORER</b> .....	<b>52</b>
27.1 LOCATION .....	52
27.2 RESPONSIBILITIES .....	52
<b>RULE 28: ASSISTANT SCORER</b> .....	<b>53</b>
28.1 LOCATION .....	53
28.2 RESPONSIBILITIES .....	53
<b>RULE 29: LINE JUDGES</b> .....	<b>53</b>
29.1 LOCATION .....	53
29.2 RESPONSIBILITIES .....	53
<b>RULE 30: OFFICIAL SIGNALS</b> .....	<b>54</b>
30.1 REFEREES' HAND SIGNALS .....	54
30.2 LINE JUDGES' FLAG SIGNALS .....	54
<b>PART 2, SECTION 3: DIAGRAMS</b> .....	<b>55</b>
DIAGRAM 1a-1 (D1a): COMPETITION CONTROL AREA (WITHOUT MEDIA) .....	56



DIAGRAM 1a-2: COMPETITION CONTROL AREA (WITH MEDIA).....	57
DIAGRAM 1b (D1b): THE PLAYING AREA.....	58
DIAGRAM 2 (D2): THE PLAYING COURT .....	59
DIAGRAM 3 (D3): DESIGN OF THE NET .....	60
DIAGRAM 4 (D4): POSITION OF PLAYERS.....	61
DIAGRAM 5a (D5a): BALL CROSSING THE VERTICAL PLANE OF THE NET TO THE OPPONENT COURT .....	62
DIAGRAM 5b (D5b): BALL CROSSING THE VERTICAL PLANE OF THE NET TO THE OPPONENT FREE ZONE.....	63
DIAGRAM 6 (D6): COLLECTIVE SCREEN .....	64
DIAGRAM 7 (D7): COMPLETED BLOCK .....	64
DIAGRAM 8 (D8): BACK-ROW PLAYER’S ATTACK .....	65
DIAGRAM 9 (D9): SANCTION SCALES .....	66
DIAGRAM 10 (D10): LOCATION OF REFEREEING CORPS AND THEIR ASSISTANTS .....	67
DIAGRAM 11 (D11): REFEREES’ OFFICIAL HAND SIGNALS .....	68
DIAGRAM 12 (D12): LINE JUDGES’ OFFICIAL FLAG SIGNALS .....	75
<b>PART 3: DEFINITIONS.....</b>	<b>77</b>

## GAME CHARACTERISTICS

Volleyball is a sport played by two teams on a playing court divided by a net. There are different versions available for specific circumstances in order to offer the versatility of the game to everyone.

The object of the game is to send the ball over the net in order to ground it on the opponent's court, and to prevent the same effort by the opponent. The team has three hits for returning the ball (in addition to the block contact).

The ball is put in play with a service: hit by the server over the net to the opponents. The rally continues until the ball is grounded on the playing court, goes "out", or a team fails to return it properly.

In Volleyball, the team winning the rally scores a point (Rally Point System). When the receiving team wins a rally, it gains a point and the right to serve, and its players rotate one position clockwise.



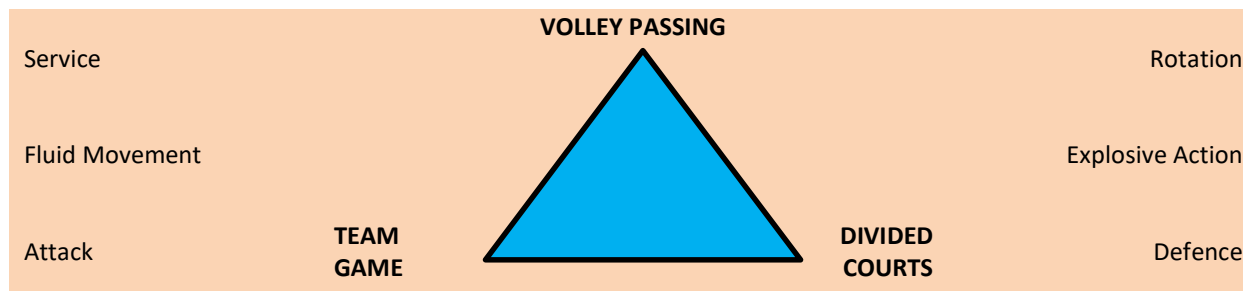
## PART 1

# PHILOSOPHY OF RULES AND REFEREEING

World ParaVolley is in agreement with FIVB, as described in the following pages.

## INTRODUCTION

By every measure, Volleyball is one of the world’s top sports – it has more affiliated federations, larger TV viewing figures, larger followers in social media, greater numbers of registered and recreational players than almost any other sport, and an image which is dynamic, clean and colorful, combining highly competitive sport and high-level show. Sitting Volleyball is one of the most successful and popular competitive and recreational Para Sports in the world and one of the only Para Sports in which athletes do not rely on technology and equipment.



William Morgan, the game’s creator, would still recognize it because Volleyball has retained certain distinctive and essential elements over the years. Some of these it shares with other net/ball/racquet games: Service – Rotation (taking turns to serve) – Attack – Defense – players able to play at the net and in the back of the court. But the sport has moved on. It is explosive, it is spectacular, it is fast and free flowing, and it has athletic players doing sensational things on court in crowded venues.

Additionally, Volleyball is unique amongst net games in insisting that the ball is in constant flight – a flying ball – and by allowing each team a degree of internal passing before the ball must be returned to the opponents, creating a kind sharing of the ball to produce equal opportunities for scoring points.

In recent years, the FIVB and World ParaVolley have made great strides in adapting the game to a modern audience, liberalizing the criteria for ball handling, introducing up to two specialist defensive ‘Libero’ players, introducing technology with the Video Challenge System to provide fairness to the effort of the athletes and encouraging policies that promote flowing play to entertain the public, both at the venue and on the screen.

## THE RULES TEXT

This text is aimed at a broad Volleyball public – players, coaches, referees, spectators, commentators and others – because an understanding of the rules allows better play and personal satisfaction – coaches can create better team structure and tactics, giving players full rein to display their skills, and an understanding of the relationship between written rules and actual actions on the court allows officials to make better decisions.

Volleyball is both recreational and competitive. Recreational sport taps into the human spirit and promotes ‘fun’ and healthy life. Competition allows people to exhibit the best of ability, creativity, freedom of expression, and fighting spirit. The rules are designed and structured to allow all of these facets to flourish.

## THE REFEREE WITHIN THIS FRAMEWORK

The essence of a good referee lies in the concept of fairness, justice and consistency (being positioned in the middle of both playing courts is a symbol of balance). Together these allow the players to trust the referee’s actions. However, the referee must be a facilitator rather than a controller, an orchestra director rather than a dictator, and an efficient promoter rather than an ‘efficient’ punisher.

By understanding the reason why a rule has been written and by being clear about its purpose within the framework of the ‘show’, the referee becomes a big part of the overall successful production, while remaining

largely in the background and intervening only when necessary. We can say that a good referee will use the rules to make the competition a fulfilling experience for all concerned.

To those who have read thus far, view the rules that follow as the current state of development of a great game, but keep in mind why these preceding few paragraphs may be of equal importance to you in your own position within the sport.

Understand the game! Get involved! Keep the ball flying!



PART 2, SECTION 1  
**RULES OF THE GAME**

## CHAPTER 1

# FACILITIES AND EQUIPMENT

1	PLAYING AREA	See Rules
	The playing area includes the playing court and the free zone. It shall be rectangular and symmetrical.	1.1, D1a, D1b
1.1	<b>DIMENSIONS</b>	D2
	The playing court is a rectangle measuring 10 x 6 m, surrounded by a free zone which is a minimum of 3 m wide on all sides.	
	The free playing space is the space above the playing area which is free from any obstructions. The free playing space shall measure a minimum of 7 m in height from the playing surface.	
	<b>For World ParaVolley, World and Official Competitions (including Zonal Championships), the free zone shall measure a minimum of 4 m from the side lines and 6 m from the end lines. The free playing space shall measure a minimum of 10 m in height from the playing surface.</b>	
1.2	<b>PLAYING SURFACE</b>	1.1, 1.3
1.2.1	The surface must be flat, horizontal and uniform. It must not present any danger of injury to the players. It is forbidden to play on rough or slippery surfaces.	
	<b>For World ParaVolley, World and Official Competitions (including Zonal Championships), only a wooden or synthetic surface is allowed. Any surface must be previously approved by World ParaVolley.</b>	
1.2.2	On indoor courts the surface of the playing court must be of a light colour.	
	<b>For World ParaVolley, World and Official Competitions (including Zonal Championships), white colours are required for the lines. Other colours, different from each other, are required for the playing court and free zone. The playing court may be of different colors differentiating the front zone and back zone.</b>	
1.2.3	On outdoor courts a slope of 5 mm per meter is allowed for drainage. Court lines made of solid material are forbidden.	1.3
1.3	<b>LINES ON THE COURT</b>	D2
1.3.1	All lines are 5 cm wide. They must be of a light colour which is different from the colour of the floor and from any other lines.	1.2.2
1.3.2	<b>BOUNDARY LINES</b>	1.1
	Two side lines and two end lines mark the playing court. Both side lines and end lines are drawn inside the dimensions of the playing court.	
1.3.3	<b>CENTER LINE</b>	D2
	The axis of the center line divides the playing court into two equal courts measuring 6 x 5 m each; however, the entire width of the line is considered to belong to both courts equally. This line extends beneath the net from side line to side line.	

1.3.4	<p><b>ATTACK LINE</b></p> <p>On each court, an attack line, whose rear edge is drawn 2 m back from the axis of the center line, marks the front zone.</p> <p><b>For World ParaVolley, World and Official Competitions (including Zonal Championships), the attack line is extended by the addition of broken lines from the side lines, with five 15 cm short lines 5 cm wide, drawn 20 cm from each other to a total length of 1.75 m.</b></p>	1.3.3, 1.4.1  D2
1.3.5	<p><b>BENCH AREA LINE</b></p> <p>In front of each team bench, there is special bench area for substitute players, which is marked 0.75 m in front of each team bench, with broken lines for the full length of team bench.</p> <p>The Bench Area Line will be marked by a series of broken lines that are 15 cm long and 5 cm wide, spaced at 20 cm intervals.</p>	
<b>1.4</b>	<b>ZONES AND AREAS</b>	D1b, D2
1.4.1	<p><b>FRONT ZONE</b></p> <p>On each court, the front zone is limited by the axis of the center line and the rear edge of the attack line.</p> <p>The front zone is considered to extend beyond the side lines to the end of the free zone.</p>	19.3.1.4, 23.3.2.3e, D2  1.3.3, 1.3.4, 19.3.1.4, 23.3.2.3e  1.1, 1.3.2
1.4.2	<p><b>SERVICE ZONE</b></p> <p>The service zone is a 6 m wide area behind each end line.</p> <p>It is laterally limited by two short lines, each 15 cm long, drawn 20 cm behind the end line as an extension of the side lines. Both short lines are included in the width of the service zone.</p> <p>In depth, the service zone extends to the end of the free zone.</p>	1.3.2, 12, D1b  1.1
1.4.3	<p><b>SUBSTITUTION ZONE</b></p> <p>The substitution zone is limited by the extension of both attack lines up to the scorer's table.</p>	1.3.4, 15.10.1, D1b
1.4.4	<p><b>LIBERO REPLACEMENT ZONE</b></p> <p>The Libero replacement zone is part of the free zone on the side of the team benches, limited by the extension of the attack line up to the end line.</p>	19.3.2.7, D1b
1.4.5	<p><b>WARM-UP AREA</b></p> <p><b>For World ParaVolley, World and Official Competitions (including Zonal Championships), the warm-up areas, sized approximately 3 x 3 m, are positioned in line with benches. The actual size and location of the Warm-Up Area will be determined by the length of the bench and the extent of the free zone, (unless otherwise specified by the Technical Delegate).</b></p>	24.2.5, D1a, D1b



**1.4.6 BENCH AREA**

For World ParaVolley, World and Official Competitions (including Zonal Championships), the bench areas, sized approximately 0.75 x 4 m, are located in front of both team benches, inside the free zone (unless otherwise specified by the Technical Delegate).

All players must remain behind this line at all times during the match, except during a substitution process or a Time Out.

Any player that is warned for being outside this designated area will be required to sit on the bench or move to the Warm-Up Area. Any player warned more than once will be sanctioned with a 'Delay'.

**1.5 TEMPERATURE**

The minimum temperature shall not be below 10°C (50°F).

**For World ParaVolley, World and Official Competitions (including Zonal Championships), the maximum temperature shall not be higher than 25°C (77°F), and the minimum not lower than 16°C (61°F).**

**1.6 LIGHTING**

Lighting should be no less than 300 lux.

**For World ParaVolley, World and Official Competitions (including Zonal Championships), the lighting on the playing area should be 1000 to 1500 lux measured at 1 m above the surface of the playing area.**

**2 NET AND POSTS**

**2.1 HEIGHT OF THE NET**

- 2.1.1 Placed vertically over the center line there is a net whose top is set at the height of 1.15 m for men and 1.05 m for women. 1.3.3, 2.1.2
- 2.1.2 Its height is measured from the center of the playing court. The net height (over the two side lines) must be exactly the same and must not exceed the official height by more than 2 cm. 1.1, 1.3.2, 2.1.1

**2.2 STRUCTURE**

The net is 0.80 m wide and 6.5 to 7 m long (with 25 to 50 cm of each side of the side bands), made of 10 cm square black mesh. D3

**For World ParaVolley, World and Official Competitions (including Zonal Championships), the net should be 7 m in length.**

At its top is a horizontal band, 7 cm wide, made of two-fold white canvas, sewn along its full length. Each extreme end of the band has a hole, through which passes a cord, fastening the band to the posts for keeping its top taut.

Within the band, a flexible cable fastens the net to the posts and keeps its top taut.

At the bottom of the net, there is another horizontal band, 5 cm wide, similar to the top band, through which threaded a rope. This rope fastens the net to the posts and keeps its lower part taut.

**2.3 SIDE BANDS**

<p>Two white side bands are fastened vertically to the net and are placed directly above each side line.</p> <p>They are 5 cm wide and 0.80 m long and are considered as part of the net.</p>	1.3.2, D3
<p><b>2.4 ANTENNAE</b></p>	
<p>An antenna is a flexible rod, 1.60 m long and 10 mm in diameter, made of fibreglass or similar material.</p>	
<p>An antenna is fastened at the outer edge of each side band. The antennae are placed on opposite sides of the net.</p>	2.3, D3
<p>The top 80 cm of each antenna extends above the net and is marked with 10 cm stripes of contrasting colour, preferably red and white.</p>	
<p>The antennae are considered as part of the net and laterally delimit the crossing space.</p>	10.1.1, D3, D5a, D5b
<p><b>2.5 POSTS</b></p>	
<p>2.5.1 The posts supporting the net are placed at a distance of 0.5 to 1.0 m outside the side lines. They are a maximum of 1.25 m high and preferably adjustable.</p> <p><b>For World ParaVolley, World and Official Competitions (including Zonal Championships), the posts supporting the net are placed at a distance of 1 m outside the side lines and must be padded. Posts should be sunk into the ground unless World ParaVolley homologated free standing, weighted posts are approved for the event.</b></p>	D3
<p>2.5.2 The posts are rounded and smooth, fixed to the ground without wires. There shall be no dangerous or obstructing devices.</p>	
<p><b>2.6 ADDITIONAL EQUIPMENT</b></p>	
<p>All additional equipment is determined by World ParaVolley regulations.</p>	
<p><b>3 BALLS</b></p>	
<p><b>3.1 STANDARDS</b></p>	
<p>The ball shall be spherical, made of a flexible leather or synthetic leather case with a bladder inside, made of rubber or a similar material.</p>	
<p>Its colour may be a uniform light colour or a combination of colours.</p>	
<p><b>Synthetic leather material and colour combinations of balls used in World ParaVolley, World and Official Competitions (including Zonal Championships), should comply with World ParaVolley standards.</b></p>	
<p>Its circumference is 65 to 67 cm and its weight is 260 to 280 g.</p>	
<p>Its inside pressure shall be 0.300 to 0.325 kg/cm<sup>2</sup> (4.26 to 4.61 psi; 294.3 to 318.8 mbar or hPa).</p>	
<p><b>3.2 UNIFORMITY OF BALLS</b></p>	
<p>All balls used in a match must have the same standards regarding circumference, weight, pressure, type, colour, etc.</p>	3.1
<p><b>World ParaVolley, World and Official Competitions (including Zonal Championships), must be played with World ParaVolley approved balls, unless by agreement of World ParaVolley.</b></p>	
<p><b>3.3 FIVE-BALL SYSTEM</b></p>	



**For World ParaVolley, World and Official Competitions (including Zonal Championships), five balls shall be used. In this case, six ball retrievers are stationed, one at each corner of the free zone and one behind each referee.**

D10

## CHAPTER 2 PARTICIPANTS

4	TEAMS	See Rules
4.1	<b>TEAM COMPOSITION</b>	
4.1.1	<p>For the match, a team may consist of up to 14 players internationally classified with a 'Confirmed' sport class status or a 'Review' sport class status, including a maximum of two players classified as 'VS2', plus:</p> <ul style="list-style-type: none"> <li>- Coaching Staff: one coach, a <b>maximum of two assistant coaches</b>, and</li> <li>- Medical Staff: <b>one team therapist</b> and one medical doctor.</li> </ul> <p>Only those listed on the score sheet may normally enter the Competition / Control Area and take part in the official warm-up and in the match.</p> <p><b>The Team Manager or Team Journalist may not sit on or behind the bench in the Control Area.</b></p> <p><b>For World ParaVolley, World and Official Competitions (including Zonal Championships), the medical doctor and team therapist must be part of the official delegation and accredited beforehand by the World ParaVolley Medical Department.</b></p>	5.2, 5.3     D1a
4.1.2	One of the players is the team captain, who shall be indicated on the score sheet.	5.1
4.1.3	Only the players recorded on the score sheet may enter the court and play in the match. Once the coach and the team captain have signed the score sheet (team list for the electronic score sheet), the recorded players cannot be changed.	1, 4.1.1, 5.1.1, 5.2.2
4.2	<b>LOCATION OF THE TEAM</b>	
4.2.1	<p>The players not in play should either sit on their team bench or be in their warm-up area. The coach and other team members sit on the bench, but may temporarily leave it.</p> <p>The benches for the team are located beside the scorer's table, outside the free zone.</p>	1.4.5, 5.2.3, 7.3.3  D1a, D1b
4.2.2	Only the team composition members are permitted to sit on the bench during the match and to participate in the official warm-up session.	4.1.1, 7.2
4.2.3	Players not in play may warm-up without balls as follows:	
4.2.3.1	during play: in the warm-up areas.	1.4.5, D1a, D1b
4.2.3.2	during time-outs: in the free zone behind their court.	1.3.3, 15.4
4.2.4	During set intervals, players may warm-up using balls within their own free zone.	18.1
4.3	<b>EQUIPMENT</b>	

A player's equipment consists of a jersey, shorts or long pants, socks (the uniform) and sport shoes. Players may play without shoes.

Players are permitted to wear tight-fitting compression garments under team shorts providing that they are of the same colour as the shorts, or white or black or neutral colours.

A compression garment, without padding, may be worn under long pants. Team members playing in long pants must use the same type / combination.

Players are not allowed to sit on thick material or to wear specially made thick shorts or pants.

- |         |  |           |
|---------|--|-----------|
| 4.3.1   | The colour and design for the jerseys, shorts or long pants, compression garments and socks must be uniform for the team ( <i>except for the Liberos</i> ). The uniforms must be clean.  | 4.1, 19.2 |
| 4.3.2   | The shoes must be light and pliable with rubber or composite soles without heels.<br><br><b>For World ParaVolley, World and Official Competitions (including Zonal Championships), it is forbidden to wear shoes with marking soles.</b> |           |
| 4.3.3   | Players' jerseys must be numbered from 1 to 99.  | 4.3.3.2   |
| 4.3.3.1 | The number must be placed on the jersey at the center of the front and of the back. The colour and brightness of the numbers must contrast with the colour and brightness of the jerseys.  |           |
| 4.3.3.2 | The number must be a minimum of 15 cm in height on the chest, and a minimum of 20 cm in height on the back. The stripe forming the numbers shall be a minimum of 2 cm in width.  |           |
| 4.3.4   | The team captain must have on his/her jersey a stripe of 8 x 2 cm underlining the number on the chest.   | 5.1       |
| 4.3.5   | It is forbidden to wear uniforms of a colour different from that of the other players (except for the Liberos), and/or without official numbers.   | 19.2      |

#### 4.4 CHANGE OF EQUIPMENT

- |       |   |             |
|-------|---|-------------|
|       | The 1 <sup>st</sup> referee may authorize one or more players:  | 23          |
| 4.4.1 | to play without shoes;<br><br><b>For World ParaVolley, World and Official Competitions (including Zonal Championships), it is forbidden to play barefoot (without socks).</b>     |             |
| 4.4.2 | to change wet or damaged uniforms between sets or after substitution, provided that the colour, design and number of the new uniform(s) are the same;                             | 4.3, 15.5   |
| 4.4.3 | to play in training suits in cold weather, provided that they are of the same colour and design for the whole team (except for the Liberos) and numbered according to Rule 4.3.3. | 4.1.1, 19.2 |

#### 4.5 FORBIDDEN OBJECTS

- |       |   |  |
|-------|---|--|
| 4.5.1 | It is forbidden to wear objects that may cause injury or give an artificial advantage to the player. Bandages may be worn, but anything that may be dangerous is not permitted. |  |
|-------|---|--|

- 4.5.2 Players may wear glasses or lenses at their own risk.
- 4.5.3 Compression pads (padded injury protection devices) may be worn for protection or support.
- For World ParaVolley, World and Official Competitions (including Zonal Championships), these devices must be of the same colour as the corresponding part of the uniform. Black, white or neutral colours may also be used, but must be the same for the whole team.**

## 5 TEAM LEADERS

Both the team captain and the coach are responsible for the conduct and discipline of their team members. 20

The Libero may be either team or game captain.

### 5.1 CAPTAIN

5.1.1 PRIOR TO THE MATCH, the team captain signs the score sheet (team list for the electronic score sheet) and represents his/her team in the toss. 7.1, 27.2.1.1

5.1.2 DURING THE MATCH and while on the court, the team captain is the game captain. When the team captain is not on the court, the coach or the team captain must assign another player on the court to assume the role of game captain. This game captain maintains his/her responsibilities until he/she is substituted, or the team captain returns to play, or the set ends. 15.2.1

When the ball is out of play, only the game captain is authorized to speak to the referees: 8.2

5.1.2.1 to ask for an explanation of the application or interpretation of the Rules, and also to submit the requests or questions of his/her teammates. If the game captain does not agree with the explanation of the 1<sup>st</sup> referee, he/she may choose to protest against such decision and immediately indicates to the 1<sup>st</sup> referee that he/she reserves the right to record an official protest on the score sheet at the end of the match; 23.2.4

5.1.2.2 to ask authorization:  
 a) to change all or part of the equipment, 4.3, 4.4.2  
 b) to verify the positions of the teams, 7.4, 7.6  
 c) to check the floor, the net, the ball, etc.; 1.2, 2, 3

5.1.2.3 in the absence of the coach, unless the team has an assistant coach who has overtaken the coach's functions, to request time-outs and substitutions. 5.2, 5.3, 15.3.1, 15.4.1, 15.5.2

5.1.3 AT THE END OF THE MATCH, the team captain: 6.3

5.1.3.1 thanks the referees and signs the score sheet to ratify the result; 27.2.3.3

5.1.3.2 may, when it has been noted in due time to the 1<sup>st</sup> referee, confirm and record on the score sheet an official protest regarding the referee's application or interpretation of the rules. 5.1.2.1, 27.2.3.2

**At World ParaVolley, World and Official Competitions (including Zonal Championships), any protest made must be written in English.**

### 5.2 COACH

5.2.1	Throughout the match, the coach conducts the play of his/her team from outside the playing court. He/she selects the starting line-ups, the substitutes, and takes time-outs. In these functions, his/her contact is the 2 <sup>nd</sup> referee.	1.1, 7.3.2, 15.4.1, 15.5.2
5.2.2	PRIOR TO THE MATCH, the coach records or checks the names and numbers of his/her players on the score sheet team roster (team list for the electronic score sheet), and then signs it.	4.1, 19.1.3, 27.2.1.1
5.2.3	DURING THE MATCH, the coach:	
5.2.3.1	prior to each set, gives the 2 <sup>nd</sup> referee or the scorer the line-up sheet(s) duly filled in and signed;	7.3.2, 7.4, 7.6
5.2.3.2	sits on the team bench nearest to the scorer, but may leave it;	4.2
5.2.3.3	requests time-outs and substitutions;	15.4, 15.5
5.2.3.4	may, as well as other team members, give instructions to the players on the court. The coach may give these instructions while standing or walking within the free zone in front of his/her team's bench from the extension of the attack line to the warm-up area, if situated in the corner of the Competition Control Area, without disturbing or delaying the match.	1.3.4, 1.4.5, D1a, D1b, D2
<b>5.3 ASSISTANT COACH</b>		
5.3.1	The assistant coach sits on the team bench, but has no right to intervene in the match.	4.2.1
5.3.2	Should the coach have to leave his/her team for any reason including sanction, but excluding entering the court as a player, an assistant coach may assume the coach's functions for the duration of the absence, once confirmed to the referee by the game captain.	5.1.2.3, 5.2

## CHAPTER 3

# PLAYING FORMAT

<b>6</b>	<b>TO SCORE A POINT, TO WIN A SET AND THE MATCH</b>	<b>See Rules</b>
<b>6.1</b>	<b>TO SCORE A POINT</b>	
6.1.1	<p><b>POINT</b></p> <p>A team scores a point:</p>	
6.1.1.1	by successfully landing the ball on the opponent's court;	8.3
6.1.1.2	when the opponent team commits a fault;	6.1.2
6.1.1.3	when the opponent team receives a penalty.	16.2.3, 21.3.1
6.1.2	<p><b>FAULT</b></p> <p>A team commits a fault by making a playing action contrary to the rules (or by violating them in some other way). The referees judge the faults and determine the consequences according to the rules:</p>	
6.1.2.1	if two or more faults are committed successively, only the first one is counted;	
6.1.2.2	If two or more faults are committed by the opponents simultaneously, a <b>DOUBLE FAULT</b> is called and the rally is replayed.	D11 (23)
6.1.3	<p><b>RALLY AND COMPLETED RALLY</b></p> <p>A <b>rally</b> is the sequence of playing actions from the moment of the service hit by the server until the ball is out of play. A <b>completed rally</b> is the sequence of playing actions which results in the award of a point. This includes:</p> <ul style="list-style-type: none"> <li>- <b>the award of a penalty.</b></li> <li>- <b>loss of service for service hit made after the time limit.</b></li> </ul>	8.1, 8.2, 12.2.2.1, 12.4.4, 15.2.3, 15.11.1.3, 19.3.2.1, 19.3.2.9, 21.3.1
6.1.3.1	If the serving team wins a rally, it scores a point and continues to serve.	
6.1.3.2	If the receiving team wins a rally, it scores a point and it must serve next.	
<b>6.2</b>	<b>TO WIN A SET</b>	D11 (9)
	A set (except the deciding 5 <sup>th</sup> set) is won by the team which scores 25 points with a minimum lead of two points. In the case of a 24 – 24 tie, play is continued until a two point lead is achieved (26 – 24; 27 – 25; etc.).	6.3.2
<b>6.3</b>	<b>TO WIN THE MATCH</b>	D11 (9)
6.3.1	The match is won by the team that wins three sets.	6.2
6.3.2	In the case of a 2 – 2 tie, the deciding 5 <sup>th</sup> set is played to 15 points with a minimum lead of 2 points.	7.1
<b>6.4</b>	<b>DEFAULT AND INCOMPLETE TEAM</b>	
6.4.1	If a team refuses to play after being summoned to do so, it is declared in default and forfeits the match with the result 0 – 3 for the match and 0 – 25 for each set.	6.2, 6.3



- 6.4.2 A team that, without justifiable reason, does not appear on the playing court on time is declared in default with the same result as in Rule 6.4.1.
- 6.4.3 A team that is declared INCOMPLETE for the set or for the match loses the set or the match. The opposing team is given the points, or the points and the sets, needed to win the set or the match. The incomplete team keeps its points and sets.

## 7 STRUCTURE OF PLAY

### 7.1 THE TOSS

- Before the match, the 1<sup>st</sup> referee carries out a toss to decide upon the first service and the sides of the court in the first set. 12.1.1
- If a deciding set is to be played, a new toss will be carried out. 6.3.2
- 7.1.1 The toss is taken in the presence of the two team captains. 5.1
- 7.1.2 The winner of the toss chooses:  
EITHER
- 7.1.2.1 the right to serve or to receive the service, 12.1.1  
OR
- 7.1.2.2 the side of the court.  
The loser takes the remaining choice.

### 7.2 OFFICIAL WARM-UP SESSION

- 7.2.1 Prior to the match, if the teams have previously had a playing court exclusively at their disposal, they are entitled to a 6 minute official warm-up period together at the net; if not, they may have 10 minutes.  
**For World ParaVolley, World and Official Competitions (including Zonal Championships), teams will be entitled to a 10 minute warm-up period together at the net.**
- 7.2.2 If either captain requests separate (consecutive) official warm-ups at the net, the teams are allowed 3 minutes each or 5 minutes each. 7.2.1
- 7.2.3 In the case of consecutive official warm-ups, the team that has the first service takes the first turn at the net. 7.1.2.1, 7.2.2  
**For World ParaVolley, World and Official Competitions (including Zonal Championships), all players must wear playing uniform for the complete Protocol and warm up.**

### 7.3 TEAM STARTING LINE-UP

- 7.3.1 There must always be six players per team in play. The six players on the court may include a maximum of one 'minimal impairment' player (VS2). If a Libero is on the court, the six players must still fulfill this requirement. 6.4.3
- The team's starting line-up indicates the rotational order of the players on the court. This order must be maintained throughout the set. 7.6
- 7.3.2 Before the start of each set, the coach has to present the starting line-up of his/her team on a line-up sheet or via electronic device (if used). The sheet is submitted, duly filled in and signed, to the 2<sup>nd</sup> referee or the scorer – or electronically sent directly to the scorer. 5.2.3.1, 24.3.1, 27.2.1.2

7.3.3	The players who are not in the starting line-up of a set are the substitutes for that set (except the Liberos).	7.3.2, 15.5
7.3.4	Once the line-up sheet has been delivered to the 2 <sup>nd</sup> referee or the scorer, no change in the line-up may be authorized without a regular substitution.	15.2.2, 15.5, D11 (5)
7.3.5	Discrepancies between players' positions on court and on the line-up sheet are dealt with as follows:	24.3.1
7.3.5.1	when such a discrepancy is discovered before the start of the set, players' positions must be rectified according to those on the line-up sheet – there will be no sanction;	7.3.2
7.3.5.2	when, before the start of the set, any player on court is found not to be registered on the line-up sheet of that set, this player must be changed to conform to the line-up sheet – there will be no sanction;	7.3.2
7.3.5.3	however, if the coach wishes to keep such non-recorded player(s) on the court, he / she has to request regular substitution(s), by use of the corresponding hand signal, which will then be recorded on the score sheet.  If a discrepancy between players' positions and the line-up sheet is discovered later, the team at fault must revert to the correct positions. The opponent's points remain valid and in addition they receive a point and the next service. All points scored by the team at fault from the exact moment of the fault up to the discovery of the fault are cancelled.	15.2.2, D11 (5)
7.3.5.4	Where a player is found to be on court but he/she is not registered on the team roster, the opponent's points remain valid, and in addition they gain a point and service. The team at fault will lose all points and/or sets (0 – 25, if necessary) gained from the moment the non-registered player entered the court, and will have to submit a revised line-up sheet and send a new registered player into the court, in the position of the non-registered player.	6.1.2, 7.3.2
<b>7.4</b>	<b>POSITIONS</b>	D4
	At the moment the ball is hit by the server, each team must be positioned within its own court (except the server).	7.6.1, 8.1, 12.4
	The players of the receiving team must be in the rotational order at the service hit.	
	The players of the serving team, however, are free to occupy any position at the service hit.	
7.4.1	The positions of the players are numbered as follows:	
7.4.1.1	the three players along the net are front-row players and occupy positions 4 (front-left), 3 (front-center) and 2 (front-right);	
7.4.1.2	the other three are back-row players occupying positions 5 (back-left), 6 (back-center) and 1 (back-right).	
7.4.2	Relative positions between players:	
7.4.2.1	each back-row player must be positioned further back from the center line than the corresponding front-row player;	
7.4.2.2	the front-row players and the back-row players, respectively, must be positioned laterally in the order indicated in Rule 7.4.1.	

7.4.3	The positions of players are determined and controlled according to the positions of their buttocks contacting the ground as follows:	D4
7.4.3.1	each front-row player must have at least a part of his/her buttocks closer to the center line than the buttocks of the corresponding back-row player;	1.3.3, 7.4.2.1, 7.4.3
7.4.3.2.	each right (left) side player must have at least a part of his/her buttocks closer to the right (left) side line than the buttocks of the center player in that row.	1.3.2, 7.4.1.2, 7.4.2.2, 7.4.3
7.4.4	After the service hit, the players of both teams may move around and occupy any position on their court and the free zone.	
<b>7.5</b>	<b>POSITIONAL FAULT</b>	D4, D11 (13)
7.5.1	The team commits a positional fault if any player is not in his/her correct position at the moment the ball is hit by the server. When a player is on court through illegal substitution, and play restarts, this is counted as a positional fault with the consequences of an illegal substitution.	7.3, 7.4, 15.9
7.5.2.	If the server commits a serving fault at the moment of the service hit, the server's fault is counted before a positional fault.	12.4, 12.7.1
7.5.3	If the service becomes faulty after the service hit, it is the positional fault that will be counted.	12.7.2
7.5.4	A positional fault leads to the following consequences:	
7.5.4.1	the team is sanctioned with a point and service to the opponent;	6.1.3
7.5.4.2	players' positions must be rectified.	7.3, 7.4
<b>7.6</b>	<b>ROTATION</b>	
7.6.1	The rotational order is determined by the team's starting line-up and controlled with the service order and players' positions throughout the set.	7.3.1, 7.4.1, 12.2
7.6.2	When the receiving team has gained the right to serve, its players rotate one position clockwise: the player in position 2 rotates to position 1 to serve, the player in position 1 rotates to position 6, etc.	12.2.2.2
<b>7.7</b>	<b>ROTATIONAL FAULT</b>	D11 (13)
7.7.1	A rotational fault is committed when the SERVICE is not made according to the rotational order. It leads to the following consequences in order:	7.6.1, 12
7.7.1.1	the scorer stops play by use of the buzzer; the opponent gains a point and next service;	6.1.3
	If the rotational fault is determined only after the completion of the rally which started with a rotational fault, only a single point is awarded to the opponent, regardless of the result of the rally played.	
7.7.1.2	the rotational order of the faulty team must be rectified.	7.6.1
7.7.2	Additionally, the scorer should determine the exact moment when the fault was committed, and all points scored subsequently by the team at fault must be cancelled. The opponent's points remain valid.	27.2.2.2
	If that moment cannot be determined, no point(s) cancellation takes place, and a point and service to the opponent is the only sanction.	6.1.3

## CHAPTER 4

# PLAYING ACTIONS

8	STATES OF PLAY	See Rules
<b>8.1</b>	<b>BALL IN PLAY</b>	
	The ball is in play from the moment of the hit of the service authorized by the 1 <sup>st</sup> referee.	12, 12.3
<b>8.2</b>	<b>BALL OUT OF PLAY</b>	
	The ball is out of play at the moment of the fault which is whistled by one of the referees; in the absence of a fault, at the moment of the whistle.	
<b>8.3</b>	<b>BALL “IN”</b>	D11 (14), D12 (1)
	The ball is IN if at any moment of its contact with the floor, some part of the ball touches the court, including the boundary lines.	1.1, 1.3.2
<b>8.4</b>	<b>BALL “OUT”</b>	
	The ball is OUT when:	
8.4.1	all parts of the ball which contact the floor are completely outside the boundary lines;	1.3.2, D11 (15), D12 (2)
8.4.2	it touches an object outside the court, the ceiling or a person out of play;	D11 (15), D12 (4)
8.4.3	it touches the antennae, ropes, posts or the net itself outside the side bands;	2.3, D3, D5a, D11 (15), D12 (4)
8.4.4	it crosses the vertical plane of the net either partially or totally outside the crossing space, except in the case of Rule 10.1.2;	2.3, D5a, D5b, D11 (15), D12 (4)
8.4.5	it crosses the lower space under the net completely.	23.3.2.3f, D5a, D11 (22)
9	PLAYING THE BALL	
	Each team must play within its own playing area and space (except Rule 10.1.2). The ball may, however, be retrieved from beyond its own free zone.	D1b
<b>9.1</b>	<b>TEAM HITS</b>	
	A hit is any contact with the ball by a player in play.	14.4.1
	The team is entitled to a maximum of three hits (in addition to blocking) to return the ball. If more are used, the team commits the fault of FOUR HITS.	
9.1.1	<b>CONSECUTIVE CONTACTS</b> A player may not hit the ball two times consecutively ( <i>except Rules 9.2.3, 14.2 and 14.4.2</i> ).	9.2.3, 14.2, 14.4.2
9.1.2	<b>SIMULTANEOUS CONTACTS</b> Two or three players may touch the ball at the same moment.	

9.1.2.1	When two (or three) teammates touch the ball simultaneously, it is counted as two (or three) hits (with the exception of blocking). If they reach for the ball, but only one of them touches it, one hit is counted. A collision of players does not constitute a fault.	
9.1.2.2	When two opponents touch the ball simultaneously over the net and the ball remains in play, the team receiving the ball is entitled to another three hits. If such a ball goes “out”, it is the fault of the team on the opposite side.	
9.1.2.3	If simultaneous hits by two opponents over the net lead to a CATCH, it is a DOUBLE FAULT and the rally is replayed.  However, a short catch is permitted when the extended contact does not stop the continuity of the play.	6.1.2.2, 9.2.2, D11 (23)  9.1.2.2
9.1.3	<b>ASSISTED HIT</b>  Within the playing area, a player is not permitted to take support from a teammate or any structure/object in order to hit the ball.  However, a player who is about to commit a fault (touch the net or cross the center line, etc.) may be stopped or held back by a teammate.	1  1.3.3, 11.4.4
<b>9.2 CHARACTERISTICS OF THE HIT</b>		
9.2.1	The ball may touch any part of the body.	
9.2.2	The ball must not be caught and/or thrown. It can rebound in any direction.	9.3.3, D11 (16)
9.2.3	The ball may touch various parts of the body, provided that the contacts take place simultaneously.  Exceptions:	
9.2.3.1	at blocking, consecutive contacts may be made by one or more player(s), provided that the contacts occur during one action;	14.1.1, 14.2
9.2.3.2	at the first hit of the team, the ball may contact various parts of the body consecutively, provided that the contacts occur during one action.	9.1, 14.4
<b>9.3 FAULTS IN PLAYING THE BALL</b>		
9.3.1	<b>FOUR HITS:</b> a team hits the ball four times before returning it.	9.1, D11 (18)
9.3.2	<b>ASSISTED HIT:</b> a player takes support from a teammate or any structure/object in order to hit the ball within the playing area.	9.1.3
9.3.3	<b>CATCH:</b> the ball is caught and/or thrown; it does not rebound from the hit.	9.2.2, D11 (16)
9.3.4	<b>DOUBLE CONTACT:</b> a player hits the ball twice in succession or the ball contacts various parts of his/her body in succession.	9.2.3, D11 (17)
9.3.5	<b>LIFTING:</b> part of the player’s body between the buttock and shoulders loses contact with the court during a playing action (exception Rule 9.4.1).	9.4.1, 9.4.2, 14.1.4, 14.6.3, D11 (26)
<b>9.4 CONTACT WITH THE COURT</b>		

- 9.4.1 At all times during playing actions, the players must contact the court with some part of the body between the buttocks and shoulders. Lifting is permitted all over the court when playing the ball in a defensive action (during 1<sup>st</sup>, 2<sup>nd</sup>, or 3<sup>rd</sup> contact) if the contact is made when the ball is not entirely higher than the top of the net.
- Players buttocks are allowed a short loss of contact with the floor at any time and in any area on the court, except when performing an attacking action.
- A loss of contact is allowed as a reaction after performing the action. If after the defensive action the ball legally crosses the vertical plane of the net, play continues.
- 9.4.2 To stand up, raise the body, or take steps is forbidden.

## 10 BALL AT THE NET

### 10.1 BALL CROSSING THE NET

- 10.1.1 The ball sent to the opponent's court must go over the net within the crossing space. The crossing space is the part of the vertical plane of the net limited as follows:
- 10.1.1.1 below, by the top of the net; 2.2
- 10.1.1.2 at the sides, by the antennae, and their imaginary extensions; 2.4
- 10.1.1.3 above, by the ceiling.
- 10.1.2 The ball, coming from the first hit of the team, that has crossed the net plane to the opponent's free zone totally or partly through the external space, may be played back, within the team hits, provided that:
- 10.1.2.1 the opponents' court is not touched by the player (except Rule 11.2.2); 11.2.2
- 10.1.2.2 the ball, when played back, crosses the net plane again totally or partly through the external space on the same side of the court – if not, it becomes ball out. 11.4.4, D5b
- The opposing team may not prevent such action.
- 10.1.2.3 The ball, sent to the opponent's free zone totally or partly through the external space, which has come from the second or third hit of the team, cannot be played back and will be judged as ball out the moment it crosses the net plane.
- 10.1.3 The ball that is heading towards the opponent's court through the lower space is in play until the moment it has completely crossed the vertical plane of the net. 23.3.2.3f, D5a, D11 (22)

### 10.2 BALL TOUCHING THE NET

While crossing the net, the ball may touch it. 10.1.1

### 10.3 BALL IN THE NET

- 10.3.1 A ball driven into the net may be recovered within the limits of the three team hits. 9.1
- 10.3.2 If the ball rips the mesh of the net or tears it down, the rally is cancelled and replayed.

<b>11</b>	<b>PLAYER AT THE NET</b>	
<b>11.1</b>	<b>REACHING BEYOND THE NET</b>	
11.1.1	In blocking, a player may touch the ball beyond the net, provided that he/she does not interfere with the opponent's play before or during the latter's attack hit.	14.1, 14.3
11.1.2	After an attack hit, a player is permitted to pass his/her hand beyond the net, provided that the contact has been made within his/her own playing space.	
<b>11.2</b>	<b>PENETRATION UNDER THE NET</b>	
11.2.1	It is permitted to penetrate into the opponent's space under the net, provided that this does not interfere with the opponent's play.	
11.2.2	It is permitted to touch the opponent's court beyond the center line with any part of the body provided that it does not interfere with the opponent's play.	1.3.3, D11 (22)
11.2.3	A player may enter the opponent's court after the ball goes out of play.	8.2
11.2.4	Players may penetrate into the opponent's free zone provided that they do not interfere with the opponent's play.	
<b>11.3</b>	<b>CONTACT WITH THE NET</b>	
11.3.1	Contact with the net by a player is not a fault, unless it interferes with the play.	11.4.4, 23.3.2.3c, 24.3.2.3, D3
11.3.2	Players may touch the post, ropes or any other object outside the antennae, including the net itself, provided that it does not interfere with the play (except Rule 9.1.3).	D3
11.3.3	When the ball is driven into the net, causing it to touch an opponent, no fault is committed.	
<b>11.4</b>	<b>PLAYER'S FAULTS AT THE NET</b>	
11.4.1	A player touches the ball or an opponent in the opponent's space before or during the opponent's attack hit.	11.1.1, D11 (20)
11.4.2	A player interferes with the opponent's play while penetrating into the opponent's space under the net.	11.2.1
11.4.3	A player penetrates into the opponent's court interfering with the opponent's play.	11.2.2, D11 (22)

- 11.4.4 A player interferes with play by (amongst others):
- touching the top band of the net between the antennae or the antenna itself during his/her action of playing the ball or attempting to play the ball,
  - using the net between the antennae as a support of stabilizing aid while playing the ball,
  - creating an unfair advantage over the opponent by touching the net
  - making actions which hinder an opponent's legitimate attempt to play the ball,
  - catching/holding on to the net.

Any player close to the ball as it is played, and who is him/herself trying to play it, is considered in the action of playing the ball, even if no contact is made with it.

However, touching the net outside the antenna is not to be considered a fault (except for Rule 9.1.3).

D11 (19)

11.3.1

## 12 SERVICE

Service is the act of putting the ball into play, by the back-right player, placed in the service zone.

1.4.2, 8.1, 12.4.1

### 12.1 FIRST SERVICE IN A SET

12.1.1 The first service of the first set, as well as that of the deciding 5<sup>th</sup> set, is executed by the team determined by the toss. 6.3.2, 7.1

12.1.2 The other sets will be started with the service of the team that did not serve first in the previous set.

### 12.2 SERVICE ORDER

12.2.1 The players must follow the service order recorded on the line-up sheet. 7.3.1, 7.3.2

12.2.2 After the first service in a set, the player to serve is determined as follows: 12.1

12.2.2.1 when the serving team wins the rally, the player (or his/her substitute) who served before, serves again; 6.1.3, 15.5

12.2.2.2 when the receiving team wins the rally, it gains the right to serve and rotates before actually serving. The player who moves from the front-right position to the back-right position will serve. 6.1.3, 7.6.2

### 12.3 AUTHORIZATION OF THE SERVICE

The 1<sup>st</sup> referee authorizes the service, after having checked that the two teams are ready to play and that the server is in possession of the ball. 12, D11 (1)

### 12.4 EXECUTION OF THE SERVICE

D11 (10)

12.4.1 The ball shall be hit with one hand or any part of the arm after being tossed or released from the hand(s).  
A service hit is allowed without tossing or releasing the ball ONLY for players with a classified hand-impairment.

12.4.2 Only one toss or release of the ball is allowed. Dribbling or moving the ball in the hands is permitted.



12.4.3	At the moment of the service hit, the server's buttocks must not touch the court (the end line included) or the floor outside the service zone. The server's foot (feet), leg(s), or hand(s) may touch the court and/or the free zone outside the service zone.	1.4.2, 29.2.1.4, D11 (22), D12 (4)
12.4.4	The server must hit the ball within 8 seconds after the 1 <sup>st</sup> referee whistles for service.	12.3, D11 (11)
12.4.5	A service executed before the referee's whistle is cancelled and repeated.	12.3
<b>12.5 SCREENING</b>		D6, D11 (12)
12.5.1	The players of the serving team must not prevent their opponent, through individual or collective screening, from seeing the service hit and the flight path of the ball.	12.5.2
12.5.2	A player or group of players of the serving team make(s) a screen by waving arms or moving sideways during the execution of the service, or by sitting grouped, and in doing so hides both the service hit and the flight path of the ball until the ball reaches the vertical plane of the net. Should either be visible to the receiving team this is not a screen, except for Rule 12.5.3.	12.4, D6
12.5.3	Any player of the serving team is forbidden to raise hands above the head during service, until the service hit. No backrow players can have their arms or hands above their shoulders. The 1 <sup>st</sup> referee is permitted to caution (advise) a team through the game captain, if they suspect that it is deliberately screening.	
<b>12.6 FAULTS MADE DURING THE SERVICE</b>		
12.6.1.	<b>SERVING FAULTS</b> The following faults lead to a change of service even if the opponent is out of position. The server:	12.2.2.2, 12.7.1
12.6.1.1	violates the serving order;	12.2
12.6.1.2	does not execute the service properly;	12.4
12.6.1.3	lifts his/her buttocks.	9.4.1
12.6.2	<b>FAULTS AFTER THE SERVICE HIT</b> After the ball has been correctly hit, the service becomes a fault (unless a player is out of position) if the ball:	12.4, 12.7.2
12.6.2.1	touches a player of the serving team or fails to cross the vertical plane of the net completely through the crossing space;	8.4.4, 8.4.5, 10.1.1, D11 (19)
12.6.2.2	goes OUT;	8.4, D11 (15)
12.6.2.3	passes over a screen.	12.5, D11 (12)
<b>12.7 SERVING FAULTS AND POSITIONAL FAULTS</b>		
12.7.1	If the server makes a fault at the moment of the service hit (improper execution, wrong rotational order, etc.) and the opponent is out of position, it is the serving fault that is sanctioned.	7.5.1, 7.5.2, 12.6.1

12.7.2 Instead, if the execution of the service has been correct, but the service subsequently becomes faulty (goes out, goes over a screen, etc.), the positional fault has taken place first and is sanctioned. 7.5.3, 12.6.2

## 13 ATTACK HIT

### 13.1 CHARACTERISTICS OF THE ATTACK HIT

12, 14.1.1

13.1.1 All actions that direct the ball towards the opponent, with the exception of the service and block, are considered as attack hits.

13.1.2 During an attack hit, tipping is permitted only if the ball is cleanly hit, and not caught or thrown. 9.2.2

13.1.3 An attack hit is completed at the moment the ball completely crosses the vertical plane of the net or is touched by an opponent.

13.1.4 To attack an opponent's service is permitted. 13.2.1

### 13.2 RESTRICTIONS OF THE ATTACK HIT

13.2.1 A front-row player may complete an attack hit at any height, provided that the contact with the ball has been made within the player's own playing space (except Rule 13.3.6). 7.4.1.1

13.2.2 A back-row player may complete an attack hit at any height from behind the front zone provided: 1.4.1, 7.4.1.2, 19.3.1.2, D8

13.2.2.1 at his/her hit, the player's buttocks must have neither touched nor crossed over the attack line; 1.3.4

13.2.2.2 after his/her hit, the player may move his/her buttocks into the front zone. 1.4.1

13.2.3 A back-row player may also complete an attack hit from the front zone, if at the moment of the contact a part of the ball is lower than the top of the net. 1.4.1, 7.4.1.2, D8

### 13.3 FAULTS OF THE ATTACK HIT

13.3.1 A player hits the ball within the playing space of the opposing team. 13.2.1, D11 (20)

13.3.2 A player hits the ball out. 8.4, D11 (15)

13.3.3 A back-row player completes an attack hit from the front zone, if at the moment of the hit the ball is entirely higher than the top of the net. 1.4.1, 7.4.1.2, 13.2.3, D11 (21)

13.3.4 A player lifts his/her buttocks at the moment he/she hits the ball. 9.3.5, 9.4.1, D11 (26)

13.3.5 A Libero completes an attack hit if at the moment of the hit the ball is entirely higher than the top of the net. 19.3.1.2, 23.3.2.3d, D11 (21)

13.3.6 A player completes an attack hit from higher than the top of the net when the ball is coming from an overhead finger pass by a Libero in his/her front zone. 1.4.1, 19.3.1.4, 23.3.2.3e, D11 (21)

## 14 BLOCK

### 14.1 BLOCKING

14.1.1	Blocking is the action of players close to the net to intercept the ball coming from the opponent by reaching higher than the top of the net, regardless of the height of the ball contact. Only front-row players are permitted to complete a block, but at the moment of the contact with the ball, a part of the body must be higher than the top of the net.	7.4.1.1
14.1.2	<b>BLOCK ATTEMPT</b> A block attempt is the action of blocking without touching the ball.	
14.1.3	<b>COMPLETED BLOCK</b> A block is completed whenever the ball is touched by a blocker.	D7
14.1.4	<b>COLLECTIVE BLOCK</b> A collective block is executed by two or three players close to each other and is completed when one of them touches the ball.	
<b>14.2</b>	<b>BLOCK CONTACT</b>	
	Consecutive (quick and continuous) contacts with the ball may occur by one or more blockers, provided that the contacts are made during one action.	9.1.1, 9.2.3
<b>14.3</b>	<b>BLOCKING WITHIN THE OPPONENT'S SPACE</b>	D11 (20)
	In blocking, the player may place his/her hands and arms beyond the net, provided that this action does not interfere with the opponent's play. Thus, it is not permitted to touch the ball beyond the net before an opponent has executed an attack hit.	13.1.1
<b>14.4</b>	<b>BLOCK AND TEAM HITS</b>	
14.4.1	A block contact is not counted as a team hit. Consequently, after a block contact, a team is entitled to three hits to return the ball.	9.1, 14.4.2
14.4.2	The first hit after the block may be executed by any player, including the one who has touched the ball during the block.	14.4.1
<b>14.5</b>	<b>BLOCKING THE SERVICE</b>	
	To block an opponent's service is permitted.	
<b>14.6</b>	<b>BLOCKING FAULTS</b>	
14.6.1	The blocker touches the ball in the opponent's space before the opponent's attack hit.	14.3
14.6.2	A back-row player or a Libero completes a block or participates in a completed block.	14.1, 19.3.1.3, D11 (12)
14.6.3	The blocker lifts his/her buttocks when he/she is playing the ball or participates in a block. <b>Lifting his/her buttocks while blocking without touching the ball is NOT a fault.</b>	9.3.5, 9.4.1, D11 (26)
14.6.4	The ball is sent out off the block.	8.4
14.6.5	Blocking the ball in the opponent's space from outside the antenna.	
14.6.6	A Libero attempts an individual or collective block.	14.1.1, 19.3.1.3

## CHAPTER 5

# INTERRUPTIONS, DELAYS AND INTERVALS

15 INTERRUPTIONS	See Rules
<p>An interruption is the time between one completed rally and the 1<sup>st</sup> referee's whistle for the next service.</p> <p>The only <b>regular game</b> interruptions are TIME-OUTS and SUBSTITUTIONS.</p>	6.1.3, 8.1, 8.2, 15.4, 15.5, 24.2.6
<h3>15.1 NUMBER OF REGULAR GAME INTERRUPTIONS</h3>	
<p>Each team may request a maximum of two time-outs and six substitutions per set.</p> <p><b>For World ParaVolley, World and Official Competitions, World ParaVolley may reduce, by one, the number of team time-outs in accordance with sponsorship, marketing and broadcast agreements.</b></p>	6.2, 15.4 15.5
<h3>15.2 SEQUENCE OF REGULAR GAME INTERRUPTIONS</h3>	
<p>15.2.1 Request for one or two time-outs, and one request for substitution by either team may follow one another, within the same interruption.</p>	15.4, 15.5
<p>15.2.2 However, a team is not authorized to make consecutive <b>requests</b> for substitution during the same interruption. Two or more players may be substituted at the same time within the same request.</p>	15.5, 15.6.1
<p>15.2.3 There must be a completed rally between two separate substitution requests by the same team (exception: a forced substitution due to injury or expulsion/disqualification (Rules 15.5.2, 15.7, 15.8)).</p>	6.1.3, 15.5
<p>15.2.4 It is not permitted to request any regular game interruption after having had a request rejected and sanctioned by a delay warning during the same interruption (i.e., before the end of the next completed rally).</p>	
<h3>15.3 REQUESTS FOR REGULAR GAME INTERRUPTIONS</h3>	
<p>15.3.1 Regular game interruptions may be requested by the coach, or in the absence of the coach, by the game captain, and only by them.</p>	5.1.2.3, 5.2.3.3, 5.3.2, 15
<p>15.3.2 Substitution before the start of a set is permitted, and should be recorded as a regular substitution in that set.</p>	7.3.4
<h3>15.4 TIME-OUTS</h3>	
<p>15.4.1 Time-out requests must be made by showing the corresponding hand signal, when the ball is out of play and before the whistle for service. All requested time-outs last for 60 seconds.</p> <p><b>For World ParaVolley, World and Official Competitions (including Zonal Championships), it is obligatory to use the buzzer and then the hand signal to request time-out.</b></p>	6.1.3, 8.2, 12.3, D11 (4)
<p>15.4.2 During all time-outs, the players in play must go to the free zone near their bench.</p>	D1a
<h3>15.5 SUBSTITUTION</h3>	

15.5.1	A substitution is the act by which a player, other than the Libero or his/her replacement player, after being recorded by the scorer, enters the game to occupy the position of another player, who must leave the court at that moment.	19.3.2.1, D11 (5)
15.5.2	When the substitution is enforced through injury to a player in play this may be accompanied by the coach (or game captain) showing the corresponding hand signal.	5.1.2.3, 5.2.3.3, 6.1.3, 8.2, 12.3, D11 (5)
<b>15.6</b>	<b>LIMITATIONS OF SUBSTITUTIONS</b>	
15.6.1	A player of the starting line-up may leave the set, but only once in a set, and re-enter, but only once in a set, and only to his/her previous position in the line-up.	7.3.1
15.6.2	A substitute player may enter the set in place of a player of the starting line-up, but only once per set, and he/she can only be substituted by the same starting player.	7.3.1
<b>15.7</b>	<b>EXCEPTIONAL SUBSTITUTION</b>	
	<p>A player (except the Libero) who cannot continue playing due to injury or illness, expulsion, or disqualification should be substituted legally. If this is not possible, the team is entitled to make an EXCEPTIONAL substitution, beyond the limits of Rule 15.6. <b>However, following the exceptional substitution, the team line-up must still conform to Rule 7.3.1.</b></p> <p>An exceptional substitution means that any player who is not on the court at the time of the injury/illness, expulsion, or disqualification, except the Libero, second Libero or their regular replacement player, may be substituted into the game for the injured/ill/expelled/disqualified player. The substituted injured/ill/expelled player is not allowed to re-enter the match.</p> <p>An exceptional substitution cannot be counted in any case as a regular substitution, but should be recorded on the score sheet as part of the total of substitutions in the set and the match.</p>	15.6, 19.4.3, 21.3.2, 21.3.3, D11 (5)
<b>15.8</b>	<b>SUBSTITUTION FOR EXPULSION OR DISQUALIFICATION</b>	
	An EXPELLED or DISQUALIFIED player must be substituted immediately through a legal substitution. If this is not possible, the team has the right to do an exceptional substitution. If no exceptional substitution is possible, the team is declared INCOMPLETE.	6.4.3, 7.3.1, 15.6, 15.7, 21.3.2, 21.3.3, D11 (5)
<b>15.9</b>	<b>ILLEGAL SUBSTITUTION</b>	
15.9.1	A substitution is illegal if it exceeds the limitations indicated in rule 7.3.1 and 15.6 (except in the case of Rule 15.7), or an unregistered player is involved.	
15.9.2	When a team has made an illegal substitution and the play has been resumed the following procedure shall apply, in sequence:	8.1, 15.6
15.9.2.1	the team is penalized with a point and service to the opponent,	6.1.3
15.9.2.2	the substitution must be rectified,	
15.9.2.3	the points scored by the team at fault since the fault was committed are cancelled; the opponent's points remain valid.	
<b>15.10</b>	<b>SUBSTITUTION PROCEDURE</b>	

15.10.1	Substitution must be carried out within the substitution zone.	1.4.3, D1b
15.10.2	A substitution shall only last the time needed for recording the substitution on the score sheet, and allowing entry and exit of the players.	15.10, 24.2.6, 27.2.2.3
15.10.3a	The actual request for substitution starts at the moment of the entrance of the substitute player(s) into the substitution zone, ready to play, during an interruption. The coach does not need to make a substitution hand signal except if the substitution is for injury or before the start of the set.	
15.10.3b	If the player is not ready at the moment of the request, the substitution is not granted and the team is sanctioned for a delay.	16.2, D9
15.10.3c	The request for substitution is acknowledged and announced by the scorer or 2 <sup>nd</sup> referee, by use of the buzzer or whistle respectively. The 2 <sup>nd</sup> referee authorizes the substitution.	24.2.6
15.10.4	If a team intends to make more than one substitution simultaneously, all substitute players must enter the substitution zone at the same time to be considered in the same request. In this case, substitutions must be made in succession, one pair of players after another. If one or more is/are illegal, the legal one(s) is/are granted, and the illegal rejected and subject to a delay sanction.	1.4.3, 15.2.2

## 15.11 IMPROPER REQUESTS

15.11.1	It is improper to request any game interruption:	15
15.11.1.1	during a rally or at the moment of or after the whistle to serve,	12.3
15.11.1.2	by a non-authorized team member,	5.1.2.3, 5.2.3.3
15.11.1.3	for a second substitution by the same team during the same interruption, except in the case of injury/illness/expulsion/disqualification of a player in play,	15.2.2, 15.2.3, 15.8, 16.1, 27.2.2.6
15.11.1.4	after having exhausted the authorized number of time-outs and substitutions.	15.1
15.11.2	The first improper request by a team in the match that does not affect or delay the match shall be rejected, but it must be recorded on the score sheet without any other consequences.	16.1, 27.2.2.6
15.11.3	Any further improper request in the match by the same team constitutes a delay.	16.1.4

## 16 GAME DELAYS

### 16.1 TYPES OF DELAY

16.1	An improper action of a team that defers resumption of the game is a delay and includes, among others:	7.4.1.1
16.1.1	delaying regular game interruptions;	15.10.2
16.1.2	prolonging interruptions, after having been instructed to resume the game;	15
16.1.3	requesting an illegal substitution;	15.9
16.1.4	repeating an improper request;	15.11.3

16.1.5	delaying the game by a team member.	
<b>16.2</b>	<b>DELAY SANCTIONS</b>	D9
16.2.1	DELAY WARNING and DELAY PENALTY are team sanctions.	
16.2.1.1	Delay sanctions remain in force for the entire match.	6.3
16.2.1.2	All delay sanctions are recorded on the score sheet.	27.2.2.6
16.2.2	The first delay in the match by a team member is sanctioned with a DELAY WARNING.	4.1.1, D11 (25)
16.2.3	The second and subsequent delays of any type by any member of the same team in the same match constitute a fault and are sanctioned with a DELAY PENALTY; a point and service to the opponent.	6.1.3, D11 (25)
16.2.4	Delay sanctions imposed before or between sets are applied in the following set.	18.1
<b>17</b>	<b>EXCEPTIONAL GAME INTERRUPTIONS</b>	
<b>17.1</b>	<b>INJURY / ILLNESS</b>	8.1
17.1.1	Should a serious accident occur while the ball is in play, the referee must stop the game immediately and permit medical assistance to enter the court. The rally is then replayed.	6.1.3
17.1.2	If an injured/ill player cannot be substituted legally or exceptionally, the player is given a 3 minute recovery time, but not more than once for the same player in the same match. If the player does not recover, his/her team is declared incomplete.	15.6, 15.7, 24.2.8 6.4.3, 7.3.1
<b>17.2</b>	<b>EXTERNAL INTERFERENCE</b>	
	If there is any external interference during the game, the play has to be stopped and the rally is replayed.	6.1.3, D11 (23)
<b>17.3</b>	<b>PROLONGED INTERRUPTIONS</b>	
17.3.1	If unforeseen circumstances interrupt the match, the 1 <sup>st</sup> referee, the Organizer and the Control Committee (if there is one) shall decide the measures to be taken to re-establish normal conditions.	23.2.3
17.3.2	Should one or several interruptions occur, not exceeding 4 hours in total:	17.3.1
17.3.2.1	if the match is resumed on the same playing court, the interrupted set shall continue normally with the same score, players (except expelled or disqualified ones) and positions. The sets already played will keep their scores;	1, 7.3
17.3.2.2	if the match is resumed on another playing court, the interrupted set is cancelled and replayed with the same team members and the same starting line-ups (except expelled or disqualified ones) and the record of all sanctions will be maintained. The sets already played will keep their scores.	7.3, 21.4.1, D9
17.3.3	Should one or several interruptions occur, exceeding 4 hours in total, the whole match shall be replayed.	
<b>18</b>	<b>INTERVALS AND CHANGE OF COURTS</b>	

**18.1****INTERVALS**

An interval is the time between sets. All intervals last 3 minutes.

During this period of time, the change of courts and line-up registrations of the teams on the score sheet are made.

The interval between the second and third set can be extended up to 10 minutes by the competent body at the request of the Organizer.

4.2.4

7.3.2, 18.2,  
27.2.1.2**18.2****CHANGE OF COURTS**

## 18.2.1

After each set, the teams change court, with the exception of the deciding set.

7.1

## 18.2.2

In the deciding set, once the leading team reaches 8 points, the teams change courts without delay and the player positions remain the same.

6.3.2, 7.4.1,  
27.2.2.5

If the change is not made once the leading team reaches 8 points, it will take place as soon as the error is noticed. The score at the time that the change is made remains the same.



## CHAPTER 6

# THE LIBERO PLAYER

19	THE LIBERO PLAYER	See Rules
<b>19.1</b>	<b>DESIGNATION OF THE LIBERO</b>	5
19.1.1	Each team has the right to designate from the list of players on the score sheet up to two specialist defensive players; Liberos.	4.1.1
19.1.2	All Liberos must be recorded on the score sheet in the special lines reserved for this.	5.2.2, 27.2.1.1, 28.2.1.1
19.1.3	The Libero on court is the Acting Libero. If there is another Libero, he/she is the second Libero for the team.  Only one Libero may be on the court at any time.	
<b>19.2</b>	<b>EQUIPMENT</b>	4.3
	The Libero player(s) must wear a uniform (or jacket/bib for the RE-DESIGNATED Libero) that has a different dominant colour from any colour of the rest of the team. The two Liberos can be in uniforms different from each other and from the rest of the team. The uniform must clearly contrast with the rest of the team.  The Libero uniforms must be numbered like the rest of the team.  <b>For World ParaVolley, World and Official Competitions (including Zonal Championships), the re-designated Libero should, if possible, wear the same style and colour of jersey as the original Libero, but keep his/her own number.</b>	
<b>19.3</b>	<b>ACTIONS INVOLVING THE LIBERO</b>	
19.3.1	PLAYING ACTIONS:	
19.3.1.1	The Libero is allowed to replace any player in a back-row position.	7.4.1.2
19.3.1.2	He/she is restricted to perform as a back-row player and is not allowed to complete an attack hit from anywhere (including the playing court and free zone) if at the moment of contact the ball is entirely higher than the top of the net.	13.2.2, 13.2.3, 13.3.5
19.3.1.3	He/she may not serve, block or attempt to block.	12.4.1, 14.6.2, 14.6.6, D11 (12)
19.3.1.4	A player may not complete an attack hit when the ball is entirely higher than the top of the net if the ball is coming from an overhand finger pass by a Libero in his/her front zone. The ball may be freely attached if the Libero makes the same action from outside his/her front zone.	1.4.1, 13.3.6, 23.3.2.3d/e, D1b
19.3.2	LIBERO REPLACEMENTS:	
19.3.2.1	Libero replacements are not counted as substitutions.  They are unlimited, but there must be a completed rally between two replacements involving a Libero (unless a penalty causes the team to rotate and the Libero to move to position 4, or the Acting Libero becomes unable to play, making the rally incomplete).	6.1.3, 15.5

19.3.2.2	The regular replacement player may replace and be replaced by either Libero. The Acting Libero can only be replaced by the regular replacement player for that position or by the second Libero.	
19.3.2.3	At the start of each set, the Libero cannot enter the court until the 2 <sup>nd</sup> referee has checked the line-up and authorized a Libero replacement with a starting player.	7.3.2, 12.1
19.3.2.4	Other Libero replacements must only take place while the ball is out of play and before the whistle for service.	8.2, 12.3
19.3.2.5	A Libero replacement made after the whistle for service but before the service hit should not be rejected; however, at the end of the rally, the game captain must be informed that this is not a permitted procedure and that repetition will be subject to delay sanctions.	12.3, 12.4, D9
19.3.2.6	Subsequent late Libero replacements shall result in the play being interrupted immediately, and the imposition of a delay sanction. The team to serve next will be determined by the level of the delay sanction.	16.2, D9
19.3.2.7	The Libero and the replacing player may only enter or leave the court through the Libero Replacement Zone.	1.4.4, D1b
19.3.2.8	Libero replacements must be recorded in the Libero Control Sheet (if one is used) or on the electronic score sheet.	28.2.2.1, 28.2.2.2
19.3.2.9	An illegal Libero replacement can involve (amongst others): <ul style="list-style-type: none"> <li>- no completed rally between Libero replacements,</li> <li>- the Libero being replaced by a player other than the second Libero or the regular replacement player.</li> </ul>	6.1.3 15.9
	An illegal Libero replacement should be considered in the same way as an illegal substitution:	15.9
	<ul style="list-style-type: none"> <li>- should the illegal Libero replacement be noticed before the start of the next rally, then this is corrected by the referees, and the team is sanctioned for delay;</li> <li>- should the illegal Libero replacement be noticed after the service hit, the consequences are the same as for an illegal substitution.</li> </ul>	D9 15.9
<b>19.4 RE-DESIGNATION OF A NEW LIBERO</b>		
19.4.1	The Libero <b>becomes</b> unable to play if injured, ill, expelled or disqualified. The Libero can be <b>declared</b> unable to play for any reason by the coach or, in the absence of a coach, by the game captain.	21.3.2, 21.3.3, D9 5.1.2.1, 5.2.1
19.4.2	TEAM WITH ONE LIBERO	
19.4.2.1	When only one Libero is available for a team according to Rule 19.4.1, or the team has only one registered, and this Libero becomes or is declared unable to play, the coach (or game captain if no coach is present) may re-designate any other player (replacement player excepted) not on the court at the moment of the re-designation as Libero.	19.4, 19.4.1

19.4.2.2	<p>If the <b>Acting</b> Libero becomes unable to play, he/she may be replaced by the regular replacement player or <b>immediately and directly to court</b> by a re-designated Libero. However, a Libero who is the subject of a re-designation may not play for the remainder of the match.</p> <p>If the Libero is not on court when declared unable to play, he/she may also be the subject of a re-designation. The Libero declared unable to play may not play for the remainder of the match.</p>	
19.4.2.3	The coach, or game captain if no coach is present, contacts the 2 <sup>nd</sup> referee informing him/her about the re-designation.	5.1.2.1, 5.2.1
19.4.2.4	Should a re-designated Libero become or be declared unable to play, further re-designations are permitted.	19.4.1
19.4.2.5	If the coach requests the team captain to be re-designated as the new Libero, this will be permitted.	19.4.1
19.4.2.6	In the case of a re-designated Libero, the number of the player re-designated as Libero must be recorded on the score sheet remarks section and on the Libero Control Sheet (or electronic score sheet) if one is used.	27.2.2.7, 28.2.2.1
19.4.3	TEAM WITH TWO LIBEROS	
19.4.3.1	<p>When a team has two Liberos registered on the score sheet, but one becomes unable to play, the team has the right to play with only one Libero.</p> <p>No re-designation will be allowed, however, unless the remaining Libero is unable to continue playing for the match.</p>	<p>4.1.1, 19.1.1</p> <p>19.4</p>
<b>19.5</b>	<b>SUMMARY</b>	
	<p>If the Libero is expelled or disqualified, he/she may be replaced immediately by the team's second Libero. Should the team have only one Libero, then it has the right to make a re-designation.</p>	19.4, 21.3.2, 21.3.3

## CHAPTER 7

# PARTICIPANTS' CONDUCT

20	REQUIREMENTS OF CONDUCT	See Rules
<b>20.1 SPORTSMANLIKE CONDUCT</b>		
20.1.1	Participants must know the Official Sitting Volleyball Rules and abide by them.	
20.1.2	Participant must accept referees' decisions with sportsmanlike conduct, without disputing them.  In case of doubt, clarification may be requested only through the game captain.	5.1.2.1
20.1.3	Participants must refrain from actions or attitudes aimed at influencing the decisions of the referees or covering up faults committed by their team.	
<b>20.2 FAIR PLAY</b>		
20.2.1	Participants must behave respectfully and courteously in the spirit of FAIR PLAY, not only towards the referees, but also towards other officials, the opponent, teammates and spectators.	
20.2.2	Communication between team members during the match is permitted.	5.2.3.4
21	MISCONDUCT AND ITS SANCTIONS	
<b>21.1 MINOR MISCONDUCT</b>		
	Minor misconduct offences are not subject to sanctions. It is the 1 <sup>st</sup> referee's duty to prevent the teams from approaching the sanctioning level.  This is done in two stages:  STAGE 1: by issuing a verbal warning through the game captain;  STAGE 2: by use of a YELLOW CARD to the team member(s) concerned. This formal warning is not in itself a sanction but a symbol that the team member (and by extension the team) has reached the sanctioning level for the match. It is recorded on the score sheet but has no immediate consequences.	5.1.2, 21.3  D9, D11 (6a)
<b>21.2 MISCONDUCT LEADING TO SANCTIONS</b>		
	Incorrect conduct by a team member towards officials, opponents, teammates or spectators is classified in three categories according to the seriousness of the offence.	4.1.1
21.2.1	RUDE CONDUCT: action contrary to good manners or moral principles.	
21.2.2	OFFENSIVE CONDUCT: defamatory or insulting words or gestures or any action expressing contempt.	
21.2.3	AGGRESSION: actual physical attack or aggressiveness or threatening behaviour.	
<b>21.3 SANCTION SCALE</b>		D9

	According to the judgement of the 1 <sup>st</sup> referee and depending on the seriousness of the offence, the sanctions to be applied and recorded on the score sheet are: <b>Penalty, Expulsion or Disqualification.</b>	21.2, 27.2.2.6
21.3.1	<b>PENALTY</b> The first rude conduct in the match by any team member is penalized with a point and service to the opponent.	D11 (6b) 4.1.1, 21.2.1
21.3.2	<b>EXPULSION</b>	D11 (7)
21.3.2.1	A team member who is sanctioned by expulsion shall not play for the remainder of the set, must be substituted legally/exceptionally and immediately if on court and must go to the team's dressing room until the completion of the set with no other consequences.  An expelled coach loses his/her right to intervene in the set and must go to the team's dressing room until the completion of the set.	4.1.1, 5.2.1, 5.3.2, 15.8, D1a, D1b  5.2.3.3
21.3.2.2	The first OFFENSIVE CONDUCT by a team member is sanctioned by expulsion with no other consequences.	4.1.1, 21.2.2
21.3.2.3	The second RUDE CONDUCT in the same match by the same team member is sanctioned by expulsion with no other consequences.	4.1.1, 21.2.1
21.3.3	<b>DISQUALIFICATION</b>	D11 (8)
21.3.3.1	A team member who is sanctioned by disqualification must be substituted legally/exceptionally and immediately if on court and must go to the team's dressing room for the rest of the match with no other consequences.	4.1.1, 15.8, D1a
21.3.3.2	The first PHYSICAL ATTACK or implied or threatened AGGRESSION is sanctioned by disqualification with no other consequences.	21.2.3
21.3.3.3	The second OFFENSIVE CONDUCT in the same match by the same team member is sanctioned by disqualification with no other consequences.	4.1.1, 21.2.2
21.3.3.4	The third RUDE CONDUCT in the same match by the same team member is sanctioned by disqualification with no other consequences.	4.1.1, 21.2.1
<b>21.4</b>	<b>APPLICATION OF MISCONDUCT SANCTIONS</b>	
21.4.1	All misconduct sanctions are individual sanction, remain in force for the entire match and are recorded on the score sheet.	21.3, 27.2.2.6
21.4.2	The repetition of misconduct by the same team member in the same match is sanctioned progressively (the team member receives a heavier sanction for each successive offence).	4.1.1, 21.2, 21.3, D9
21.4.3	Expulsion or disqualification due to offensive conduct or aggression does not require a previous sanction.	21.2, 21.3
<b>21.5</b>	<b>MISCONDUCT BEFORE AND BETWEEN SETS</b>	
	Any misconduct occurring before or between sets is sanctioned according to Rule 21.3 and sanctions apply in the following set.	18.1, 21.2, 21.3
<b>21.6</b>	<b>SUMMARY OF MISCONDUCT AND CARDS USED</b>	D11 (6a, 6b, 7, 8)

Warning: no sanction	21.1
- STAGE 1: verbal warning	
- STAGE 2: symbol YELLOW card	
Penalty: sanction – symbol RED card	21.3.1
Expulsion: sanction – symbol YELLOW and RED cards jointly	21.3.2
Disqualification: sanction – symbol YELLOW and RED cards separately	21.3.3



PART 2, SECTION 2

**THE REFEREES, THEIR RESPONSIBILITIES  
AND OFFICIAL HAND SIGNALS**

## CHAPTER 8

# REFEREES

22	REFEREEING TEAM AND PROCEDURES	See Rules
<b>22.1</b>	<b>COMPOSITION</b>	
	The refereeing team for a match is composed of the following officials:	
	- The 1 <sup>st</sup> referee,	23
	- The 2 <sup>nd</sup> referee,	24
	- The Challenge referee,	25
	- The Reserve referee,	26
	- The scorer,	27
	- Four (two) line judges.	29
	Their location is shown in Diagram 10.	
	<b>For World ParaVolley, World and Official Competitions (including Zonal Championships), a Challenge referee (if VCS is in use), a Reserve referee, and an assistant scorer is compulsory.</b>	25, 26, 28
<b>22.2</b>	<b>PROCEDURES</b>	
22.2.1	Only the 1 <sup>st</sup> and 2 <sup>nd</sup> referees may blow a whistle during the match:	
22.2.1.1	the 1 <sup>st</sup> referee gives the signal for the service that begins the rally;	6.1.3, 12.3
22.2.1.2	the 1 <sup>st</sup> or 2 <sup>nd</sup> referee signals the end of the rally, provided that they are sure that a fault has been committed and they have identified its nature.	
22.2.2	They may blow the whistle when the ball is out of play to indicate that they authorize or reject a team request.	5.1.2, 8.2
22.2.3	Immediately after the referee's whistle to signal completion of the rally, they have to indicate with the official hand signals:	22.2.1.2, 30.1
22.2.3.1	if the fault is whistled by the 1 <sup>st</sup> referee, he/she will indicate in order:	
	a) the team to serve,	12.2.2, D11 (2)
	b) the nature of the fault,	
	c) the player(s) at fault (if necessary).	
22.2.3.2	If the fault is whistled by the 2 <sup>nd</sup> referee, he/she will indicate:	
	a) the nature of the fault,	12.2.2
	b) the player(s) at fault (if necessary),	
	c) the team to serve following the hand signal of the 1 <sup>st</sup> referee.	12.2.2
	In this case, the 1 <sup>st</sup> referee <b>does not show either</b> the nature of the fault or the player at fault, but only the team to serve.	D11 (2)
22.2.3.3	In the case of an attack hit fault or blocking fault by back-row or Libero players, both referees indicate according to Rules 22.2.3.1 and 22.2.3.2 above.	12.2.2, 13.3.3, 13.3.5, 19.3.1.2, 23.3.2.3d/e, D11 (21)



22.2.3.4	In the case of a double fault both referees indicate in order: a) the nature of the fault, b) the players at fault (if necessary), The team to serve next is then indicated by the 1 <sup>st</sup> referee.	17.3, D11 (23) 12.2.2, D11 (2)
<b>23</b>	<b>1<sup>st</sup> REFEREE</b>	
<b>23.1</b>	<b>LOCATION</b>	
	The 1 <sup>st</sup> referee performs his/her functions standing behind the post located at one end of the net on the opposite side to the scorer.	D1a, D1b, D10
<b>23.2</b>	<b>AUTHORITY</b>	
23.2.1	The 1 <sup>st</sup> referee directs the match from the start until the end. He/she has authority over all members of the refereeing corps and the members of the teams. During the match his/her decisions are final. He/she is authorized to overrule the decisions of other members of the refereeing corps, if it is noticed that they are mistaken. He/she may even replace a member of the refereeing corps who is not performing his/her functions properly.	4.1.1, 6.3
23.2.2	He/she also controls the work of the ball retrievers, floor wipers and quick moppers.	3.3
23.2.3	He/she has the power to decide any matters involving the game, including those not provided for in the rules.	
23.2.4	He/she shall not permit any discussion about his/her decisions. However, at the request of the game captain, the 1 <sup>st</sup> referee will give an explanation on the application or interpretation of the rules upon which he/she has based the decision. If the game captain does not agree with this explanation and chooses to protest against such decision, he/she must immediately reserve the right to file and record this protest at the conclusion of the match. The 1 <sup>st</sup> referee must authorize this right of the game captain.	20.1.2 5.1.2.1 5.1.2.1, 5.1.3.2, 27.2.3.2
23.2.5	The 1 <sup>st</sup> referee is responsible for determining before and during the match whether the playing area, equipment and the conditions meet playing requirements.	Chapter 1, 23.3.1.1
<b>23.3</b>	<b>RESPONSIBILITIES</b>	
23.3.1	Prior to the match, the 1 <sup>st</sup> referee:	
23.3.1.1	inspects the condition of the playing area, the balls and other equipment;	Chapter 1, 23.2.5
23.3.1.2	performs the toss with the team captains;	7.1
23.3.1.3	controls the teams' warm-up.	7.2
23.3.2	During the match, he/she is authorized:	
23.3.2.1	to issue warnings to the teams;	21.1

23.3.2.2	to sanction misconducts and delays;	16.2, 21.2, D9, D11 (6a, 6b, 7, 8, 25)
23.3.2.3	to decide upon:	
	a) the faults of the server and of the positions of the serving team, including the screen;	7.4, 12.4, 12.5, 12.7.1, D4, D6, D11 (12, 13)
	b) the faults in playing the ball, including lifting;	9.3, 9.4, D11 (16, 17, 18, 26)
	c) the faults above the net, and the faulty contact of the player with the net, primarily (but not exclusively) on the attacker's side;	11.3.1, 11.4.1, 11.4.4, D11 (20)
	d) the attack hit faults of the Libero and back-row players;	13.3.3, 13.3.5, 24.3.2.4, D8, D11 (21)
	e) the completed attack hits made by a player on a ball above net height coming from an overhead pass with fingers by the Libero in his/her front zone;	1.4.1, 13.3.6, 24.3.2.4, D11 (21)
	f) the ball completely crossing the lower space under the net;	8.4.5, 24.3.2.7, D5a, D11 (22)
	g) the completed block by back-row players or the attempted block by the Libero;	14.6.2, 14.6.6, D11 (12)
	h) the ball that crosses the net totally or partly outside of the crossing space to the opponent's court or contacts the antenna on his/her side of the playing court;	D11 (15)
	i) the served ball and the 3 <sup>rd</sup> hit passing over or outside the antenna on his/her side of the court.	D11 (15)
23.3.3	At the end of the match, he/she checks the score sheet and signs it.	24.3.3, 27.2.3.3
<b>24</b>	<b>2<sup>nd</sup> REFEREE</b>	
<b>24.1</b>	<b>LOCATION</b>	
	The 2 <sup>nd</sup> referee performs his/her functions standing outside the playing court near the post, on the opposite side of and facing the 1 <sup>st</sup> referee.	D1a, D1b, D10
<b>24.2</b>	<b>AUTHORITY</b>	
24.2.1	The 2 <sup>nd</sup> referee is the assistant of the 1 <sup>st</sup> referee, but also has his/her own range of jurisdiction. Should the 1 <sup>st</sup> referee become unable to continue his/her work, the 2 <sup>nd</sup> referee may replace him/her	24.3
24.2.2	He/she may, without whistling, also signal faults outside his/her range of jurisdiction, but may not insist on them to the 1 <sup>st</sup> referee.	24.3
24.2.3	He/she controls the work of the scorer(s).	27.2, 28.2

24.2.4	He/she supervises the team members on the team bench and reports their misconduct to the 1 <sup>st</sup> referee.	4.2.1
24.2.5	He/she controls the players in the warm-up area.	4.2.3
24.2.6	He/she authorizes the regular game interruptions, controls their duration and rejects improper requests.	15, 15.11, 27.2.2.3
24.2.7	He/she controls the number of time-outs and substitutions used by each team, and reports the 2 <sup>nd</sup> time-out and 5 <sup>th</sup> and 6 <sup>th</sup> substitutions to the 1 <sup>st</sup> referee and the coach concerned.	15.1, 27.2.2.3
24.2.8	In the case of an injury of a player, he/she authorizes an exceptional substitution or grants a 3 minute recovery time.	15.7, 17.1.2
24.2.9	He/she checks the floor condition, mainly in the front zone. He/she also checks, during the match, that the balls still fulfill the regulations.	1.2.1, 3
	<b>For World ParaVolley, World and Official Competitions (including Zonal Championships), the duty recorded under Rule 24.2.5 is carried out by the Reserve Referee.</b>	

### 24.3 RESPONSIBILITIES

24.3.1	At the start of each set, at the change of courts in the deciding set and whenever necessary, the 2 <sup>nd</sup> referee checks that the actual positions of the players on the court correspond to those on the line-up sheets.	5.2.3.1, 7.3.2, 7.3.5, 18.2.2
24.3.2	During the match, he/she decides, whistles and signals:	
24.3.2.1	penetration into the opponent's court, and the space under the net;	1.3.3, 11.2, D5a, D11 (22)
24.3.2.2	positional faults of the receiving team;	7.5, D4, D11 (13)
24.3.2.3	the faulty contact of the player with the net primarily (but not exclusively) on the blocker's side and with the antenna on his/her side of the court;	11.3.1
24.3.2.4	the completed block by back-row players or the attempted block by the Libero; or the attack hit fault by back-row players or by the Libero;	13.3.3, 14.6.2, 14.6.6, 23.3.2.3d/e/g, D11 (12, 21)
24.3.2.5	the contact of the ball with an outside object;	8.4.2, 8.4.3, D11 (15)
24.3.2.6	the contact of the ball with the floor when the 1 <sup>st</sup> referee is not in position to see the contact;	8.3
24.3.2.7	the ball that crosses the net totally or partly outside of the crossing space to the opponent's court or contacts the antenna on his/her side of the court;	8.4.3, 8.4.4, D5a, D11 (15)
24.3.2.8	lifting faults, especially by the blockers;	9.3.5, 9.4.1
24.3.2.9	The served ball and the 3 <sup>rd</sup> hit passing over or outside the antenna on his/her side of the court.	D11 (15)
24.3.3	At the end of the match, he/she checks the score sheet and signs it.	23.3.3, 27.2.3.3

**For World ParaVolley, World, and Official Competitions (including Zonal Championships), if the Video Challenge System is in use a Challenge referee is compulsory.**

### 25.1 LOCATION

The Challenge referee carries out his/her function in the challenge booth located in a separate position determined by the World ParaVolley Technical Delegate.

### 25.2 RESPONSIBILITIES

- 25.2.1 He/she supervises the challenge process and ensures that it proceeds according to the challenge regulation in force.
- 25.2.2 The challenge referee shall wear the official referee uniform while performing his/her functions.
- 25.2.3 After the challenge process, he/she advises the 1<sup>st</sup> referee of the nature of the fault.
- 25.2.4 At the end of the match, he/she signs the score sheet.

## 26 RESERVE REFEREE

**For World ParaVolley, World, and Official Competitions (including Zonal Championships), a Reserve referee is compulsory.**

### 26.1 LOCATION

The Reserve referee carries out his/her functions located in a separate position determined by the World ParaVolley court layout.

### 26.2 RESPONSIBILITIES

The Reserve referee is obliged to:

- 26.2.1 Wear an official referee uniform while performing his/her functions;
- 26.2.2 Replace the 2<sup>nd</sup> referee in the case of absence or in case that he/she is unable to continue his/her work or in case that the 2<sup>nd</sup> referee becomes the 1<sup>st</sup> referee;
- 26.2.3 Control the substitution paddles (if they are in use) before the match and between sets;
- 26.2.4 Check the operation of the bench tablets before and between the sets, if there is a problem;
- 26.2.5 Assist the 2<sup>nd</sup> referee in keeping the free zone clear; 1.1
- 26.2.6 Assist the 2<sup>nd</sup> referee in instructing the expelled/disqualified team member to leave to the team's dressing room; 21.3.2.1, 21.3.3.1
- 26.2.7 Control the substitute players in the warm-up area and on the bench; 1.4.5, 24.2.5
- 26.2.8 Bring the 2<sup>nd</sup> referee four match balls immediately after the presentation of the starting players, and give the 2<sup>nd</sup> referee a match ball after he/she has finished checking the players' positions; 24.3.1
- 26.2.9 Assist the 1<sup>st</sup> referee with guiding the work of the moppers. 23.2.2

<b>27</b>	<b>SCORER</b>	
<b>27.1</b>	<b>LOCATION</b>	
	The scorer performs his/her functions seated at the scorer's table on the opposite side of the court from and facing the 1 <sup>st</sup> referee.	D1a, D1b, D10
<b>27.2</b>	<b>RESPONSIBILITIES</b>	
	He/she fills in the score sheet according to the Rules, co-operating with the 2 <sup>nd</sup> referee.	
	He/she uses a buzzer or other sound device to notify irregularities or gives signals to the referees on the basis of his/her responsibilities.	
27.2.1	Prior to the match and set, the scorer:	
27.2.1.1	registers the data of the match and teams, including the names and numbers of the Liberos, according to the procedures in force, and obtains the signatures of the captains and the coaches;	4.1, 5.1.1, 5.2.2, 7.3.2, 19.1.2, 19.4.2.6
27.2.1.2	records the starting line-up of each team from the line-up sheet (or checks the data submitted electronically).	5.2.3.1, 7.3.2
	If he/she fails to receive the line-up sheets on time, he/she immediately notifies this fact to the 2 <sup>nd</sup> referee.	5.2.3.1
27.2.2	During the match, the scorer:	
27.2.2.1	records the points scored;	6.1
27.2.2.2	controls the serving order of each team and indicates any error to the referees immediately after the service hit;	12.2
27.2.2.3	is empowered to acknowledge and announce requests for player substitutions by use of the buzzer, controlling their number, and records the substitutions and time-outs, informing the 2 <sup>nd</sup> referee;	15.1, 15.4.1, 15.10.3c, 24.2.6, 24.2.7
27.2.2.4	notifies the referees of a request for a regular game interruption that is out of order;	15.11
27.2.2.5	announces the ends of the sets to the referees, and the scoring of the 8 <sup>th</sup> point in the deciding set;	6.2, 15.4.1, 18.2.2
27.2.2.6	records misconduct warnings, sanctions and improper requests;	15.11.3, 16.2, 21.3
27.2.2.7	records all other events as instructed by the 2 <sup>nd</sup> referee; i.e. exceptional substitutions, recovery time, prolonged interruptions, external interference, re-designation, etc.;	15.7, 17.1.2, 17.2, 17.3, 19.4
27.2.2.8	controls the interval between sets.	18.1
27.2.3	At the end of the match, the scorer:	
27.2.3.1	records the final result;	6.3
27.2.3.2	in the case of protest, with the previous authorization of the 1 <sup>st</sup> referee, writes or permits the team/game captain to write on the score sheet a statement on the incident being protested;	5.1.2.1, 5.2.3.2, 23.2.4

27.2.3.3 signs the score sheet him/herself, before obtaining the signatures of the team captains and then the referees.

5.1.3.1, 23.3.3,  
24.3.3

## 28 ASSISTANT SCORER

### 28.1 LOCATION

The assistant scorer performs his/her functions seated beside the scorer at the scorer's table.

22.1, D1a, D1b,  
D10

### 28.2 RESPONSIBILITIES

19.3

He/she records the replacements involving the Libero.

He/she assists with the administrative duties of the scorer's work.

Should the scorer become unable to continue his/her work, the assistant scorer substitutes for the scorer.

28.2.1 Prior to the match and set, the assistant scorer:

28.2.1.1 prepares the Libero Control Sheet;

28.2.1.2 prepares the reserve score sheet.

28.2.2 During the match, the assistant scorer:

28.2.2.1 records the details of the Libero replacements/re-designations;

19.3.1.1, 19.4

28.2.2.2 notifies the referees of any fault of the Libero replacement, by using the buzzer;

19.3.2

28.2.2.3 operates the manual scoreboard on the scorer's table;

28.2.2.4 checks that the scoreboards agree;

27.2.2.1

28.2.2.5 if necessary, updates the reserve score sheet and gives it to the scorer.

27.2.1.1

28.2.3 At the end of the match, the assistant scorer:

28.2.3.1 signs the Libero Control Sheet and submits it for checking;

28.2.3.2 signs the score sheet.

**For World ParaVolley, World and Official Competitions (including Zonal Championships) which use an e-score sheet, the Assistant Scorer acts with the Scorer to announce the substitutions, to direct the 2<sup>nd</sup> Referee to the team requesting an interruption, and identify the Libero replacements.**

## 29 LINE JUDGES

### 29.1 LOCATION

If only two line judges are used, they stand at the corners of the court closest to the right hand of each referee, diagonally at 1 to 2 m from the corner.

D1a, D1b, D10

Each one of them controls both the end line and side line on his/her side.

**For World ParaVolley, World and Official Competitions (including Zonal Championships), it is compulsory to have four line judges.**

**They stand in the free zone at 1 to 2 m from each corner of the court, on the imaginary extension of the line that they control.**

D10

### 29.2 RESPONSIBILITIES

29.2.1	The line judges perform their functions by using flags (40 x 40 cm) to signal:	D12
29.2.1.1	the ball IN or OUT whenever the ball lands near their line(s);	8.3, 8.4, D12 (1, 2)
29.2.1.2	the touches of out balls by the team receiving the ball;	8.4, D12 (3)
29.2.1.3	the ball touching the antenna, the served ball and the third hit of the team crossing the net outside the crossing space, etc.;	8.4.3, 8.4.4, 10.1.1, D5a, D12 (4)
29.2.1.4	any player (except the server) who has at least a part of their buttocks outside of his/her court at the moment of service hit;	7.4, 12.4.3, D12 (4)
29.2.1.5	the buttocks faults of the server;	12.4.3, D12 (4)
29.2.1.6	Any contact with the top 80 cm of the antenna on their side of the court by any player during his/her action of playing the ball or interfering with the play;	11.3.1, 11.4.4, D3, D12 (4)
29.2.1.7	the ball crossing the net outside the crossing space into the opponent's court or touching the antenna on his/her side of the court.	10.1.1, D5a, D12 (4)
29.2.2	At the 1 <sup>st</sup> referee's request, a line judge must repeat his/her signal.	

**30 OFFICIAL SIGNALS**

**30.1 REFEREES' HAND SIGNALS**

D11

The referees must indicate, with the official hand signal, the reason for their whistle (the nature of the fault whistled or the purpose of the interruption authorized). The signal has to be maintained for a moment and, if it is indicated with one hand, the hand corresponds to the side of the team which has made the fault or the request.

**30.2 LINE JUDGES' FLAG SIGNALS**

D12

The line judges must indicate, with the official flag signal, the nature of the fault called and maintain the signal for a moment.



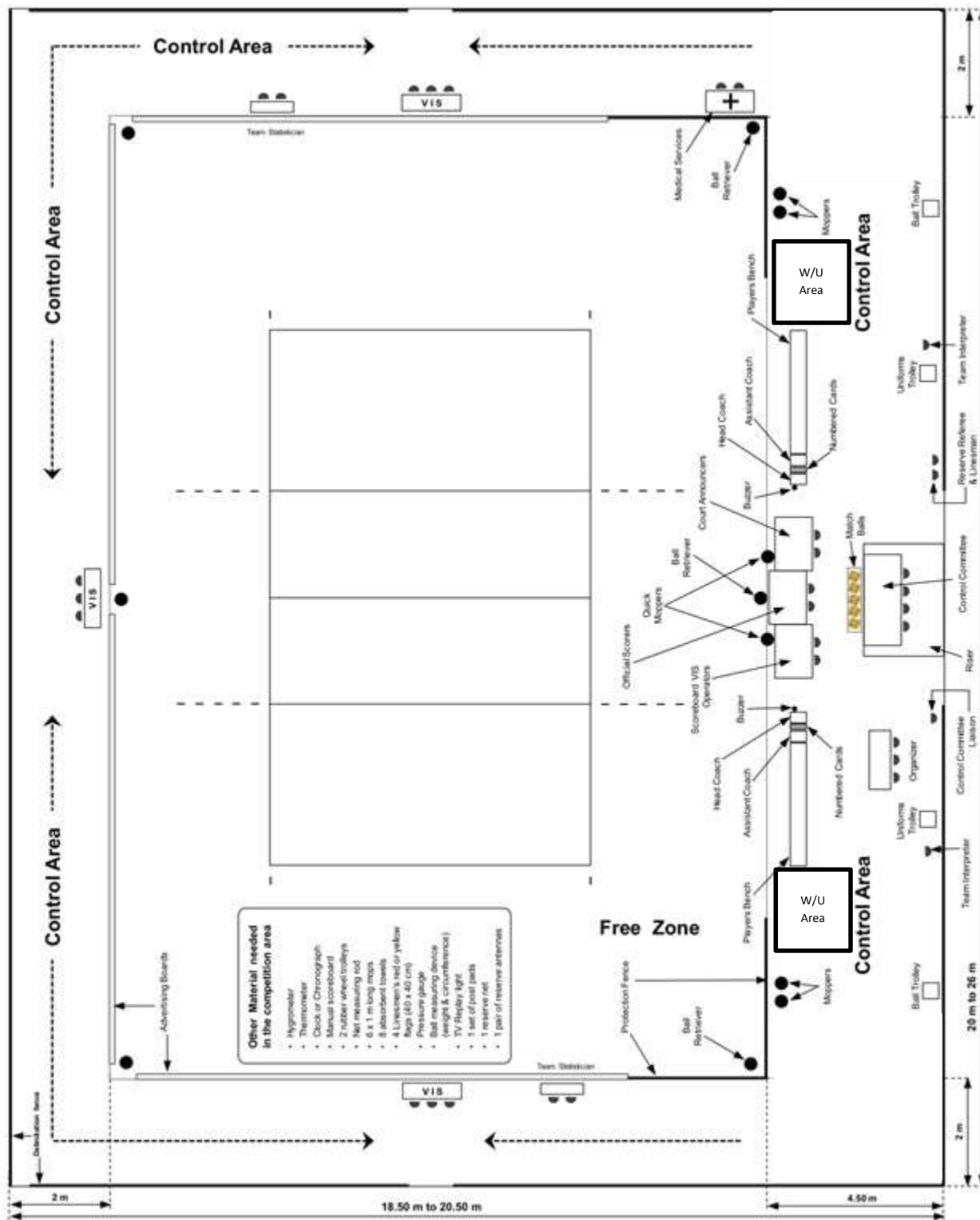
PART 2, SECTION 3

**DIAGRAMS**

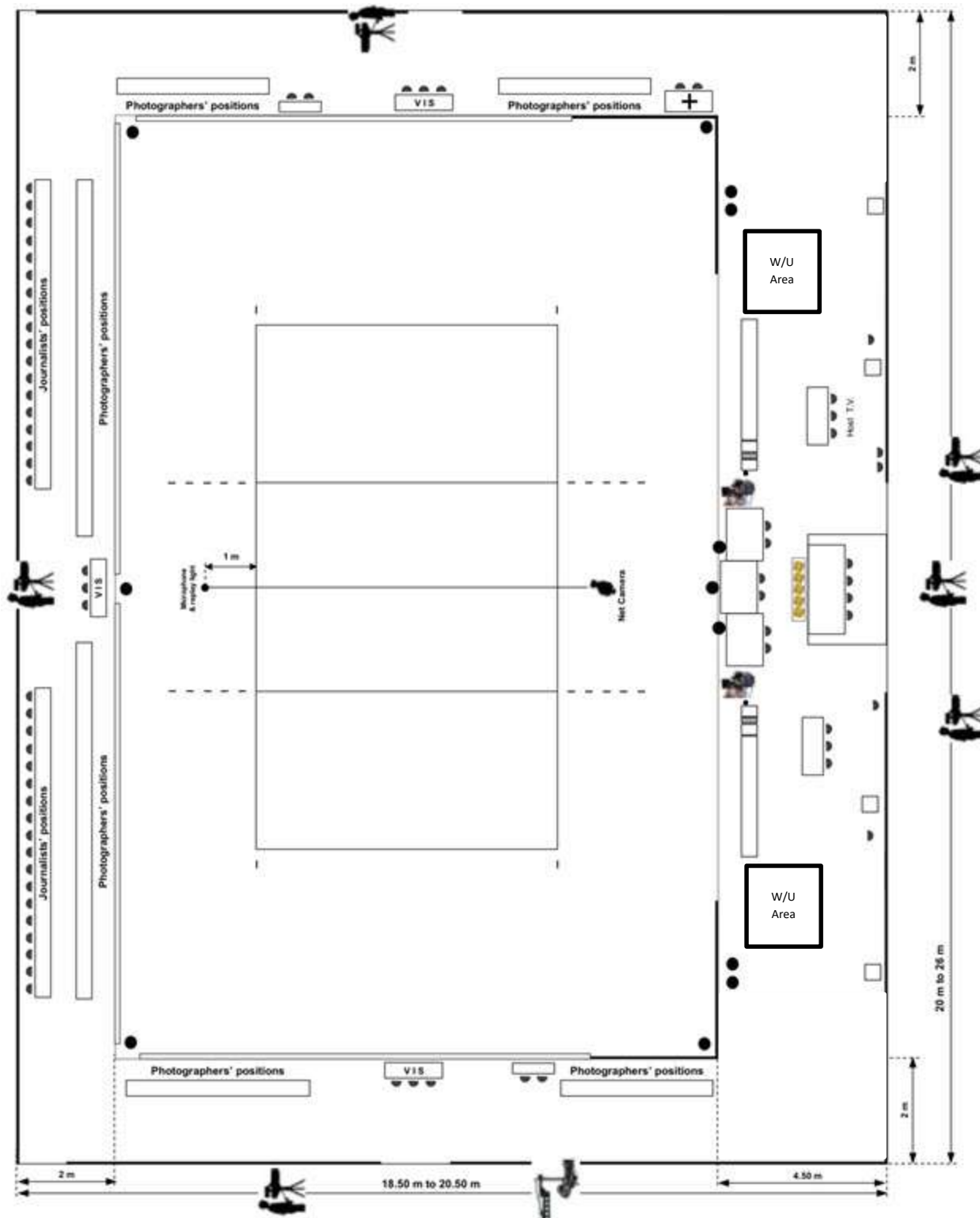


**DIAGRAM 1a-1 (D1a): COMPETITION CONTROL AREA (WITHOUT MEDIA)**

Relevant Rules: 1, 1.4.5, 4.2.1, 4.2.3.1, 15.4.4, 19.3.2.7, 21.3.2.1, 21.3.3.1, 23.1, 24.1, 27.1, 28.1

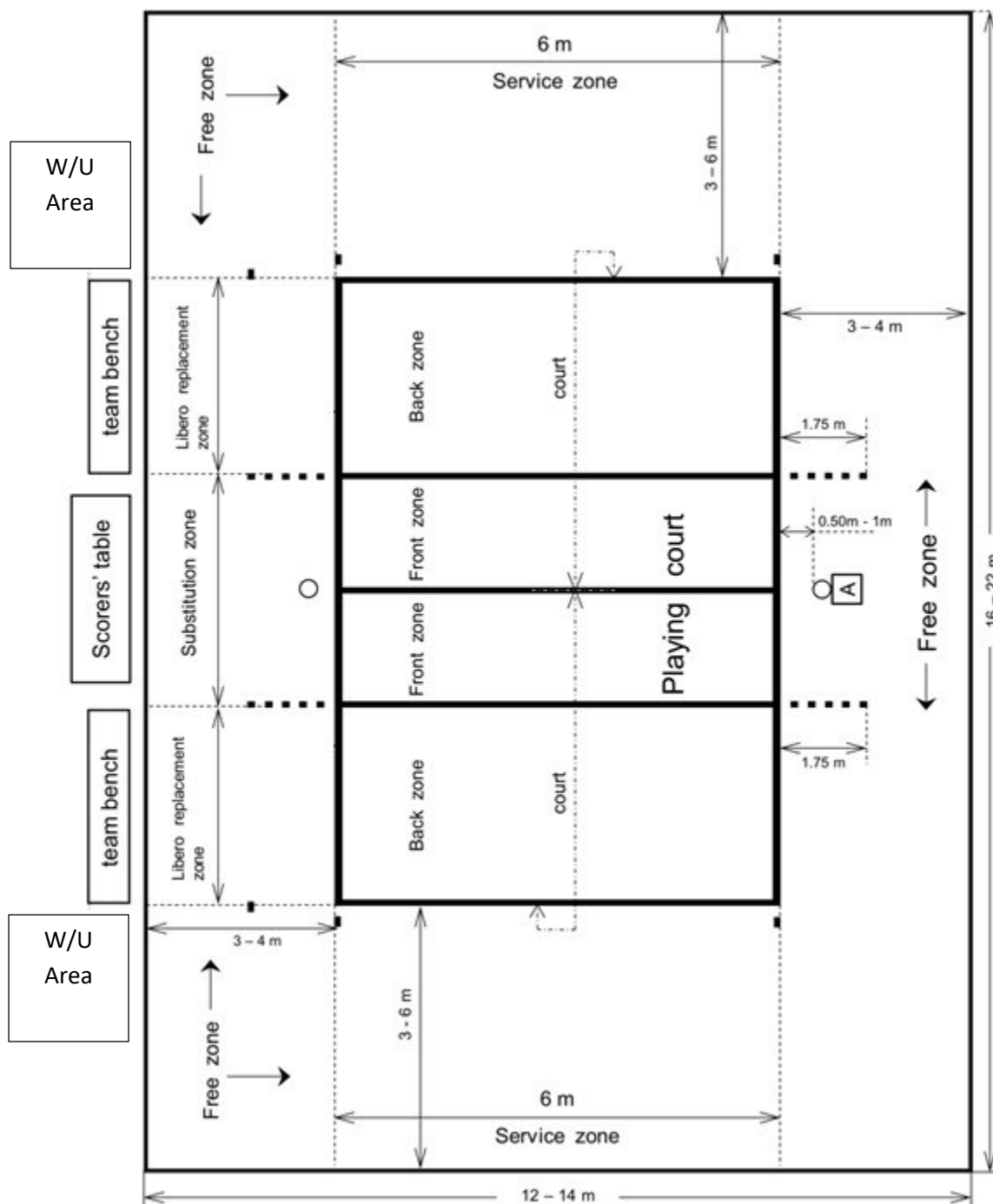


**DIAGRAM 1a-2: COMPETITION CONTROL AREA (WITH MEDIA)**



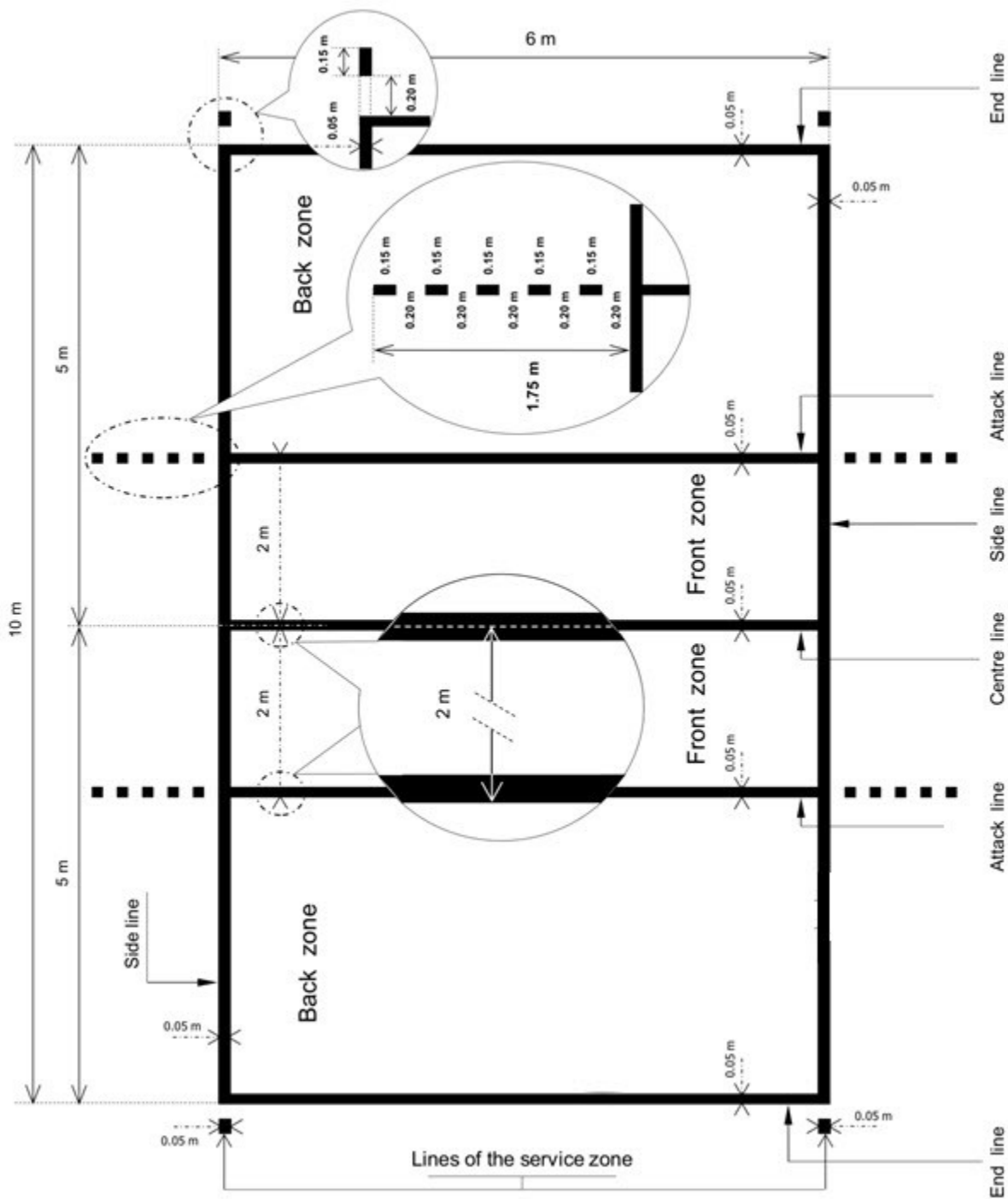
**DIAGRAM 1b (D1b): THE PLAYING AREA**

Relevant Rules: 1, 1.4, 1.4.2, 1.4.3, 1.4.4, 1.4.5, 4.2.1, 4.2.3.1, 15.10.1, 19.3.1.4, 19.3.2.7, 21.3.2.1, 23.1, 24.1, 27.1, 28.1



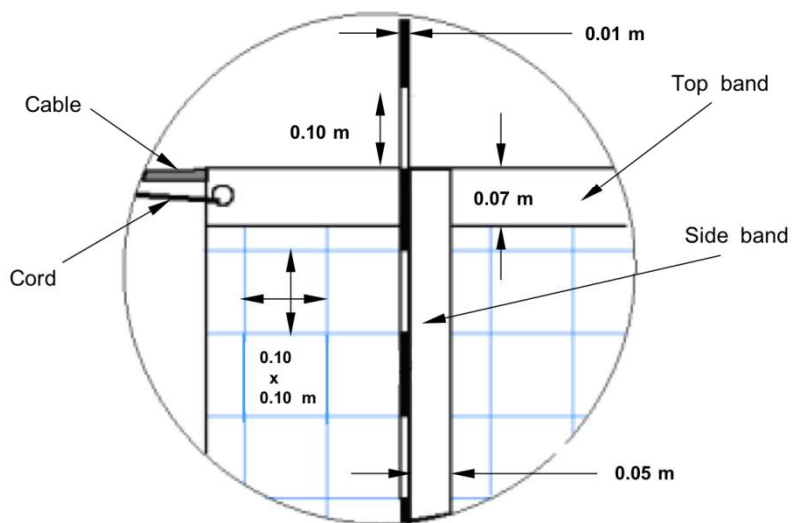
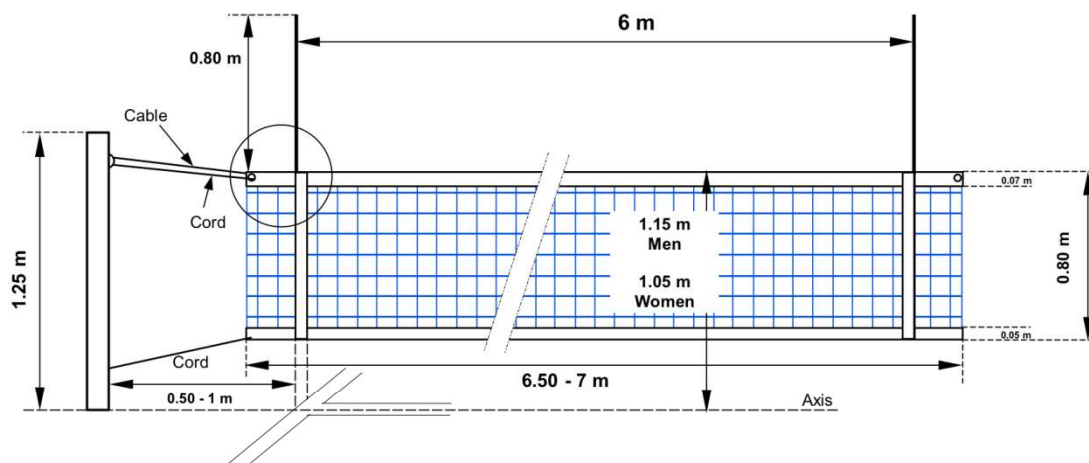
**DIAGRAM 2 (D2): THE PLAYING COURT**

Relevant Rules: 1.1, 1.3, 1.3.3, 1.3.4, 1.4.1, 5.2.3.4



**DIAGRAM 3 (D3): DESIGN OF THE NET**

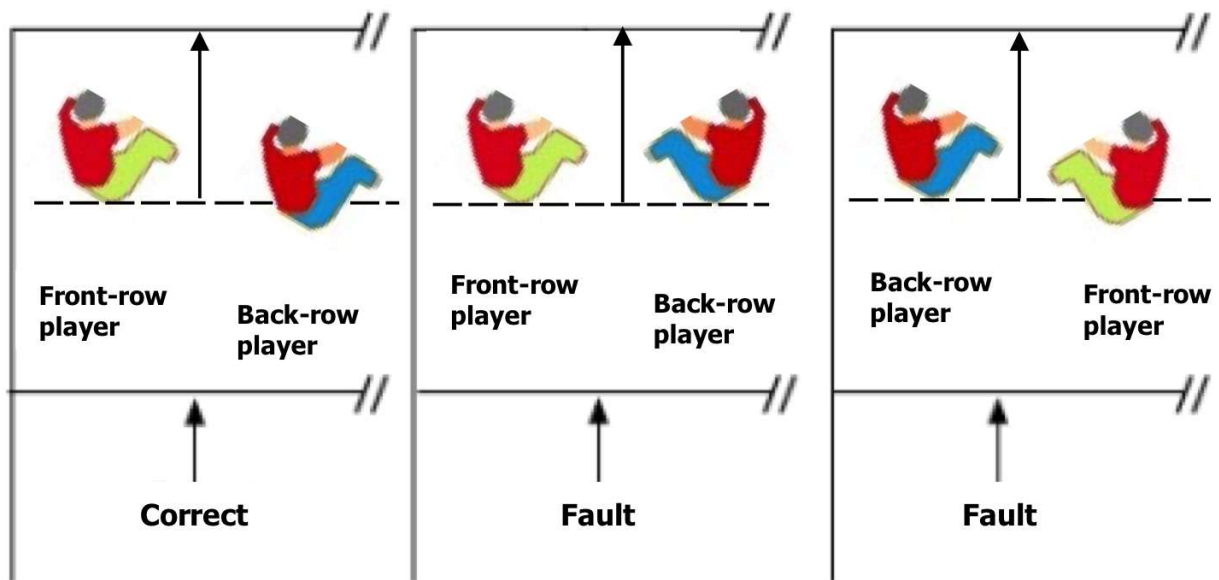
Relevant Rules: 2, 2.1.6, 2.2, 2.3, 2.4, 2.5.1, 11.3.1, 11.3.2, 29.2.1.6



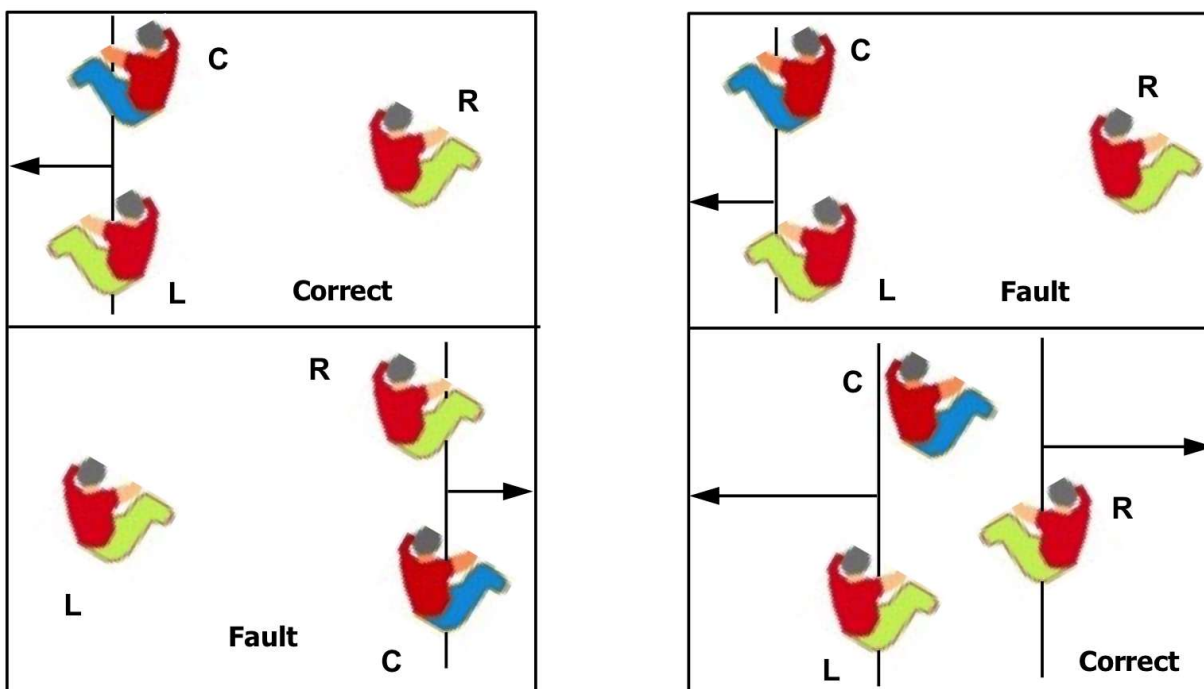
**DIAGRAM 4 (D4): POSITION OF PLAYERS**

Relevant Rules: 7.4, 7.4.3, 7.5, 23.3.2.3a, 24.3.2.2

EXAMPLE A: Determination of the positions between front-row player and the corresponding back-row player



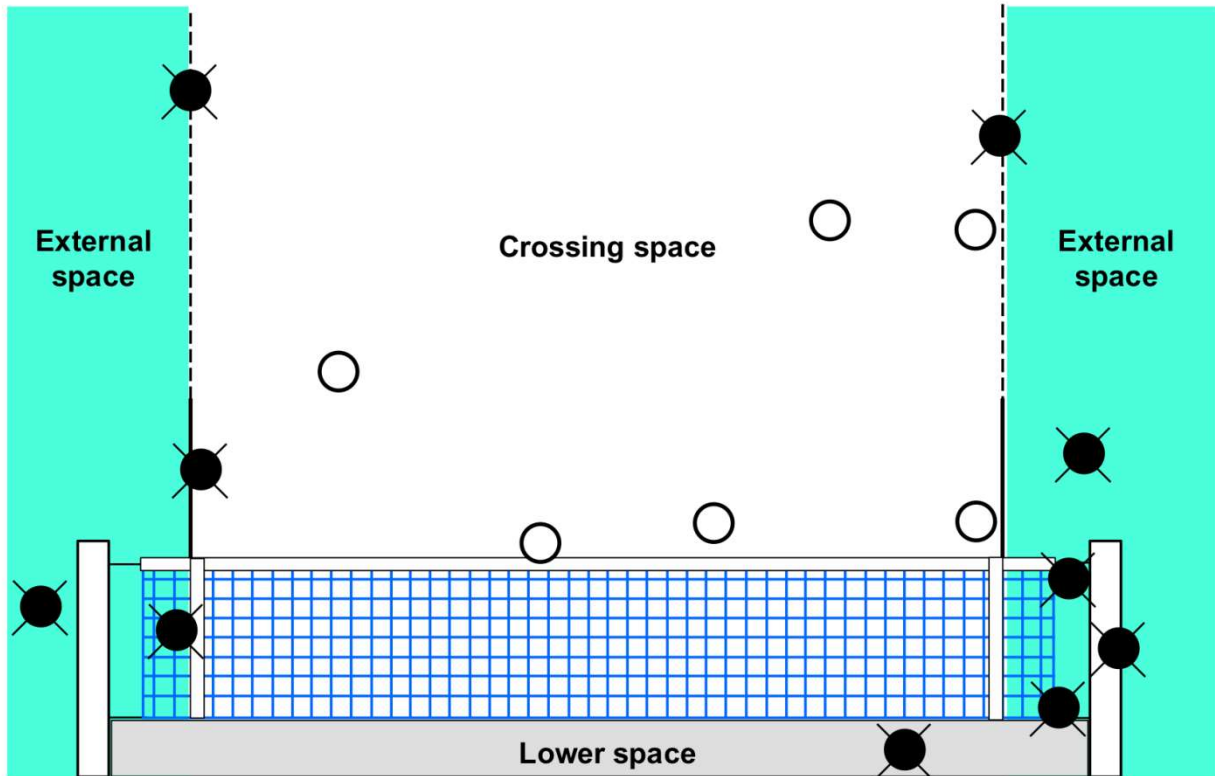
EXAMPLE B: Determination of the positions between players in the same row



C = centre player    R = right player    L = left player

**DIAGRAM 5a (D5a): BALL CROSSING THE VERTICAL PLANE OF THE NET TO THE OPPONENT COURT**

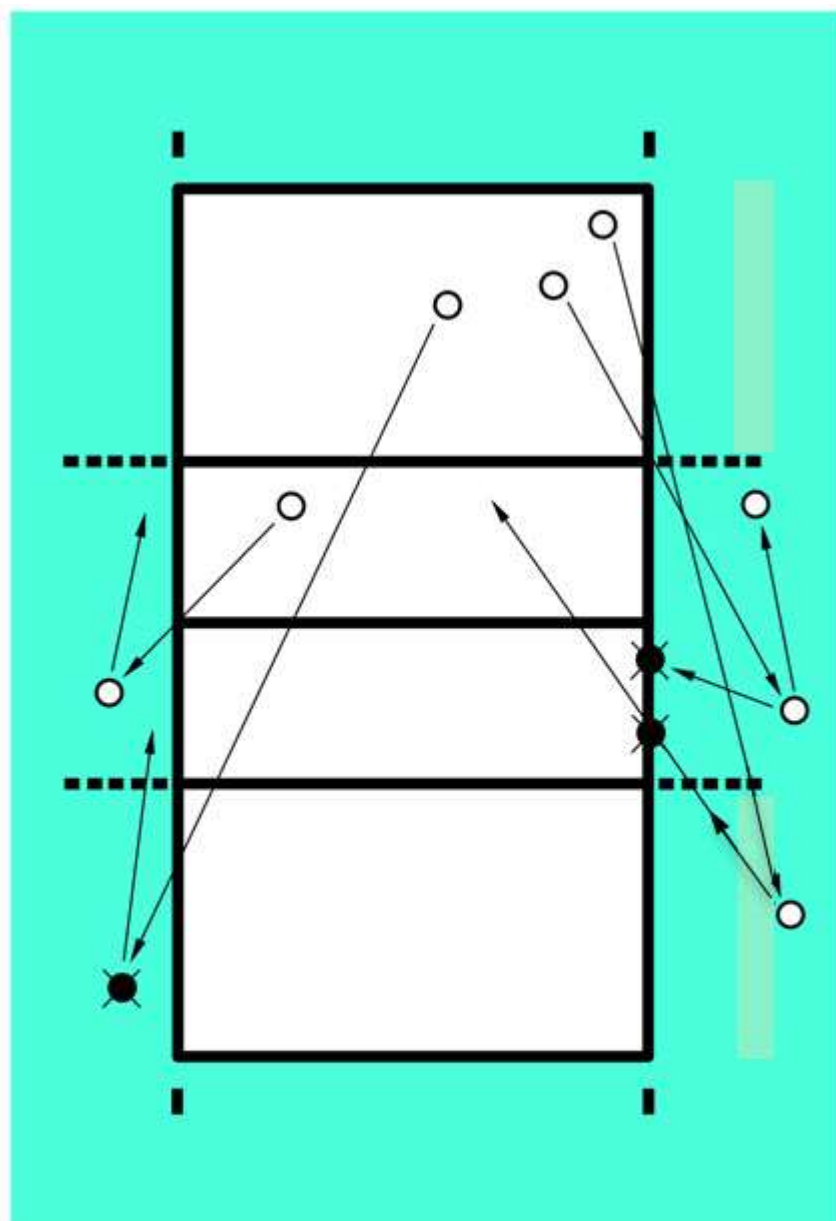
Relevant Rules: 2.4, 8.4.3, 8.4.4, 8.4.5, 10.1.1, 10.1.3, 24.3.2.7, 29.2.1.3, 29.2.1.7



- ⊗ = Fault
- = Correct crossing

**DIAGRAM 5b (D5b): BALL CROSSING THE VERTICAL PLANE OF THE NET TO THE OPPONENT FREE ZONE**

Relevant Rules: 10.1.2, 10.1.2.2, 24.3.2.7

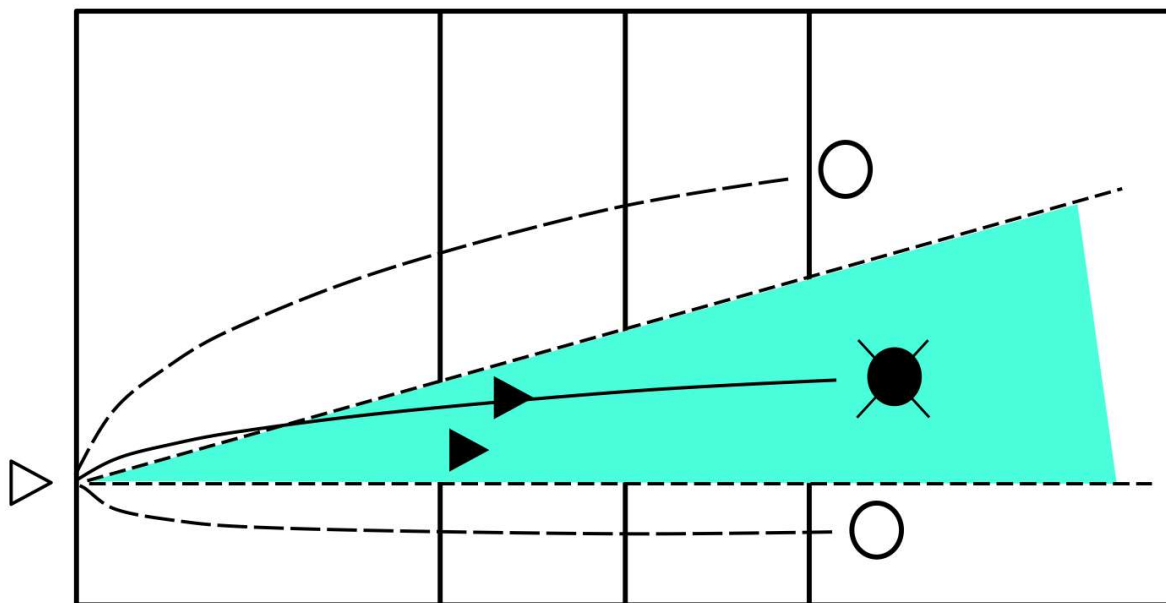


● = Fault  
○ = Correct



**DIAGRAM 6 (D6): COLLECTIVE SCREEN**

Relevant Rules: 10.1.2, 10.1.2.2, 24.3.2.7

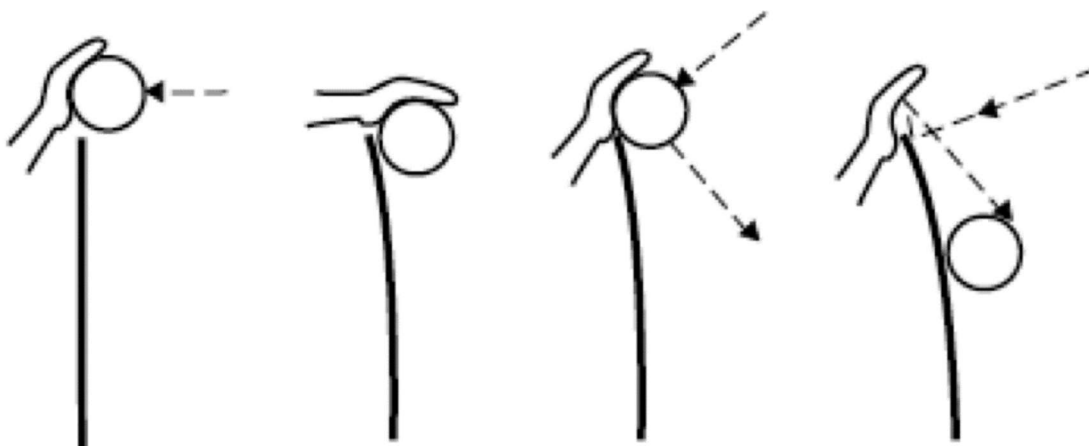


○ = Correct

⊗ = Fault

**DIAGRAM 7 (D7): COMPLETED BLOCK**

Relevant Rules: 14.1.3



**Ball above  
the net**

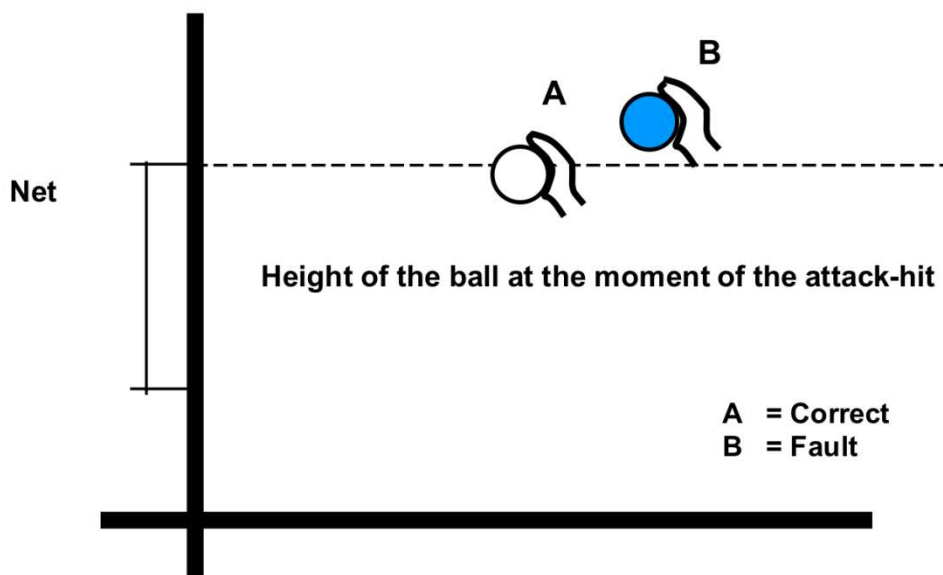
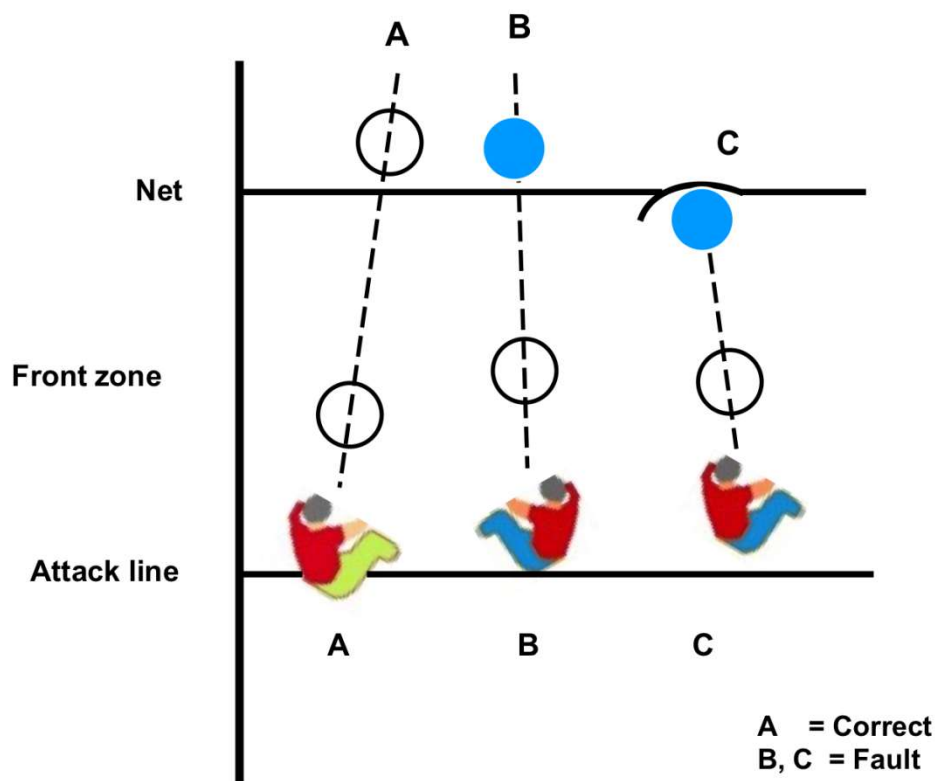
**Ball lower than  
the top of the net**

**Ball touches  
the net**

**Ball bounces  
off the net**

**DIAGRAM 8 (D8): BACK-ROW PLAYER'S ATTACK**

Relevant Rules: 13.2.2, 13.2.3, 23.3.2.3d, 24.3.2.4



**DIAGRAM 9 (D9): SANCTION SCALES**

Relevant Rules: 16.2, 21.3, 21.4.2

**9a: MISCONDUCT WARNINGS AND SANCTIONS**

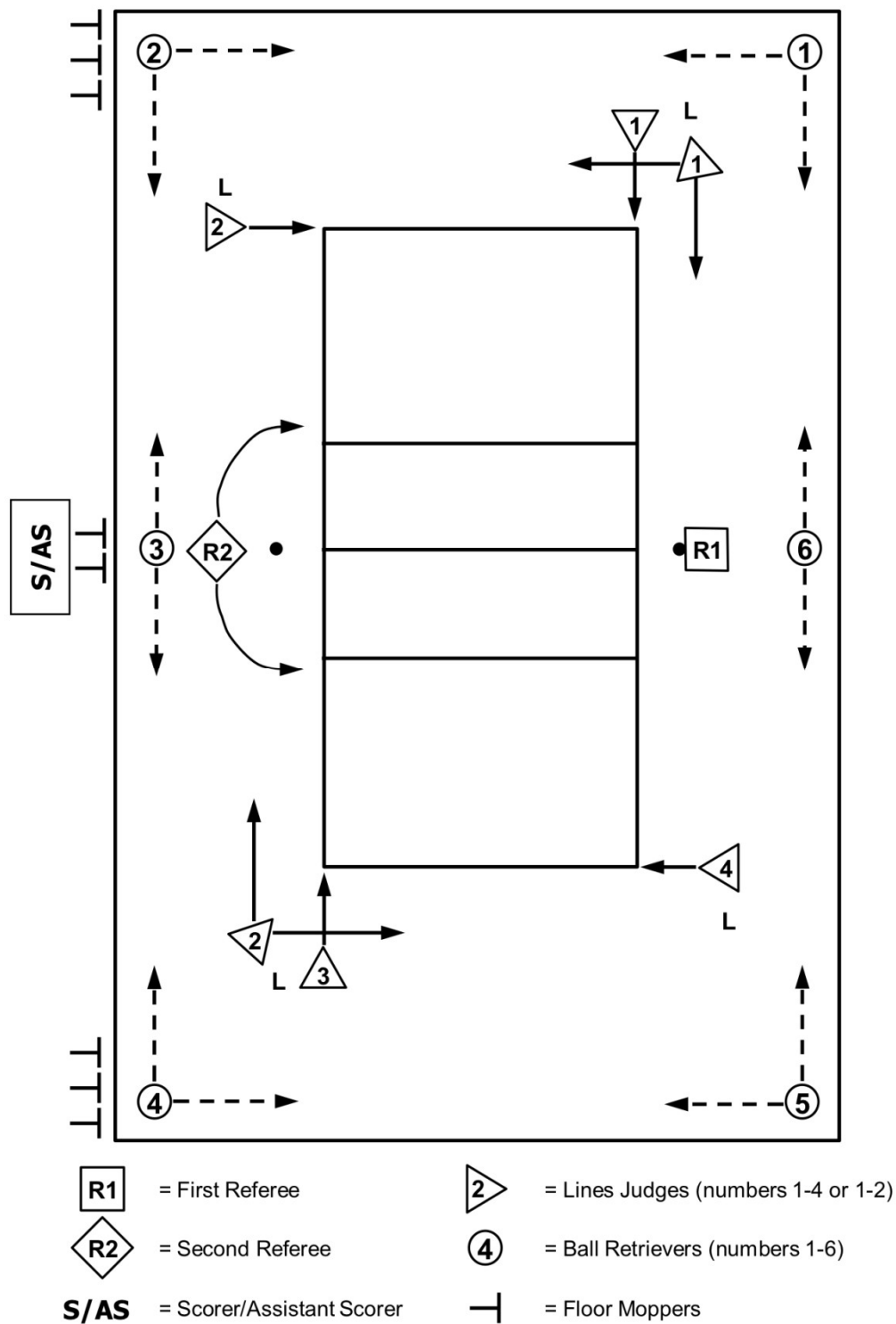
CATEGORIES	OCCURRENCE	OFFENDER	SANCTION	CARDS (SIGNAL)	CONSEQUENCE
<b>MINOR MISCONDUCT</b>	Stage 1	Any member	Not considered as sanction	None	Prevention only
	Stage 2			Yellow (D11, 6a)	
	Repetition any time		Penalty	As below	As below
<b>RUDE CONDUCT</b>	First	Any member	Penalty	Red (D11, 6b)	A point and service to the opponent
	Second	Same member	Expulsion	Red and Yellow jointly (D11, 7)	Player leaves playing area and stays in the team's dressing room for the remainder of the set
	Third	Same member	Disqualification	Red and Yellow separately (D11, 8)	Player leaves the Competition Control Area for the remainder of the match
<b>OFFENSIVE CONDUCT</b>	First	Any member	Expulsion	Red and Yellow jointly (D11, 7)	Player leaves playing area and stays in the team's dressing room for the remainder of the set
	Second	Same member	Disqualification	Red and Yellow separately (D11, 8)	Player leaves the Competition Control Area for the remainder of the match
<b>AGGRESSION</b>	First	Any member	Disqualification	Red and Yellow separately (D11, 8)	Player leaves the Competition Control Area for the remainder of the match

**9b: DELAY WARNING SYMBOLS AND SANCTIONS**

CATEGORIES	OCCURRENCE	OFFENDER	DETERRENT OR SANCTION	CARDS (SIGNAL)	CONSEQUENCE
<b>DELAY</b>	First	Any member of the team	Delay Warning	Yellow (D11, 25)	Prevention – no penalty
	Second and subsequent	Any member of the team	Delay Penalty	Red (D11, 25)	A point and service to the opponent

**DIAGRAM 10 (D10): LOCATION OF REFEREEING CORPS AND THEIR ASSISTANTS**

Relevant Rules: 3.3, 23.1, 24.1, 27.1, 28.1, 29.1



## DIAGRAM 11 (D11): REFEREES' OFFICIAL HAND SIGNALS

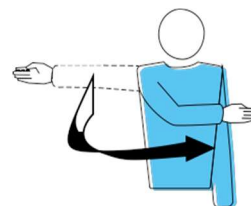
Legend: **1** **2** Referee(s) who must show the signal according to their regular responsibilities  
 ① ② Referee(s) who show the signal in special situations

### 1 AUTHORIZATION TO SERVE

*Relevant Rules: 12.3, 22.2.1.1*

Move the hand to indicate the direction of service

**1**

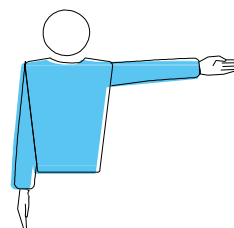


### 2 TEAM TO SERVE

*Relevant Rules: 22.2.3.1, 22.2.3.2, 22.2.3.4*

Extend the arm to the side of team that will serve

**1** **2**

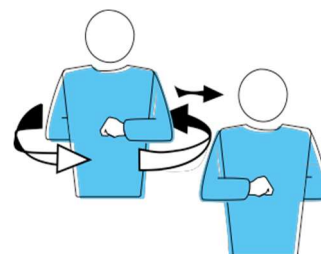


### 3 CHANGE OF COURTS

*Relevant Rule: 18.2*

Raise the forearms front and back and twist them around the body

**1**

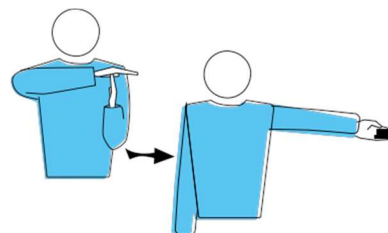


### 4 TIME-OUT

*Relevant Rule: 15.4.1*

Place the palm of one hand over the fingers of the other, held vertically (forming a T) and then indicate the requesting team

① **2**



**DIAGRAM 11 (D11): REFEREES' OFFICIAL HAND SIGNALS (CONTINUED)**

Legend:      ① ② Referee(s) who must show the signal according to their regular responsibilities  
                  ① ② Referee(s) who show the signal in special situations

**5 SUBSTITUTION**

*Relevant Rules: 15.5.1, 15.5.2, 15.8*

Circular motion of the forearms around each other

① ②



**6a MISCONDUCT WARNING**

*Relevant Rules: 21.1, 21.6*

Show a YELLOW card for warning

①



**6b MISCONDUCT PENALTY**

*Relevant Rules: 21.3.1, 21.6, 23.3.2.2*

Show a RED card for penalty

①



**7 EXPULSION**

*Relevant Rules: 21.3.2, 21.6, 23.3.2.2*

Show both cards jointly for expulsion

①



**DIAGRAM 11 (D11): REFEREES' OFFICIAL HAND SIGNALS (CONTINUED)**

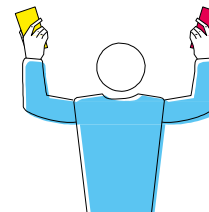
Legend:      ① ② Referee(s) who must show the signal according to their regular responsibilities  
                  ① ② Referee(s) who show the signal in special situations

**8 DISQUALIFICATION**

*Relevant Rules: 21.3.3, 21.6, 23.3.2.2*

Show RED and YELLOW cards separately for disqualification

①



**9 END OF SET (OR MATCH)**

*Relevant Rules: 6.2, 6.3*

Cross the forearms in front of the chest, hands open

① ②

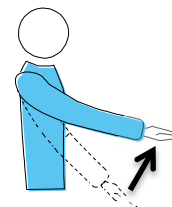


**10 BALL NOT TOSSED OR RELEASED AT THE SERVICE HIT**

*Relevant Rule: 12.4.1*

Lift the extended arm, the palm of the hand facing upwards

①



**11 DELAY IN SERVICE**

*Relevant Rule: 12.4.4*

Raise eight fingers, spread open

①



**DIAGRAM 11 (D11): REFEREES' OFFICIAL HAND SIGNALS (CONTINUED)**

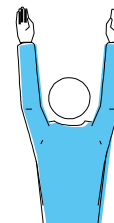
Legend:      ① ② Referee(s) who must show the signal according to their regular responsibilities  
                  ① ② Referee(s) who show the signal in special situations

**12 BLOCKING FAULT OR SCREENING**

*Relevant Rules: 12.5, 12.6.2.3, 14.6.3, 19.3.1.3, 23.3.2.3a/g, 24.3.2.4*

Raise both arms vertically, palms forward

① ②



**13 POSITIONAL OR ROTATIONAL FAULT**

*Relevant Rules: 7.5, 7.7, 23.3.2.3a, 24.3.2.2*

Make a circular motion with the forefinger

① ②

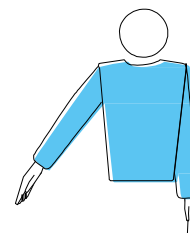


**14 BALL IN**

*Relevant Rule: 8.3*

Point the arm and fingers towards the floor

① ②



**15 BALL OUT**

*Relevant Rules: 8.4.1, 8.4.2, 8.4.3, 8.4.4, 23.3.2.3h/i, 24.3.2.5, 24.3.2.7*

Raise the forearms vertically, hands open, palms towards the body

① ②





**DIAGRAM 11 (D11): REFEREES' OFFICIAL HAND SIGNALS (CONTINUED)**

Legend:      ① ② Referee(s) who must show the signal according to their regular responsibilities  
                  ① ② Referee(s) who show the signal in special situations

**16 CATCH**

*Relevant Rules: 9.2.2, 9.3.3, 23.3.2.3b*

Slowly lift the forearm, palm of the hand facing upwards

①



**17 DOUBLE CONTACT**

*Relevant Rules: 9.3.4, 23.3.2.3b*

Raise two fingers, spread open

①

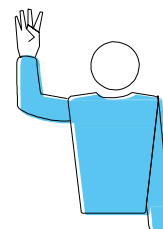


**18 FOUR HITS**

*Relevant Rules: 9.3.1, 23.3.2.3b*

Raise four fingers, spread open

①

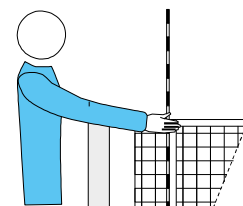


**19 NET TOUCHED BY PLAYER or  
 SERVED BALL TOUCHES THE NET BETWEEN THE ANTENNAE AND DOES NOT PASS THE VERTICAL PLANE  
 OF THE NET**

*Relevant Rules: 11.4.4, 12.6.2.1*

Indicate the relevant side of the net with the corresponding hand

① ②



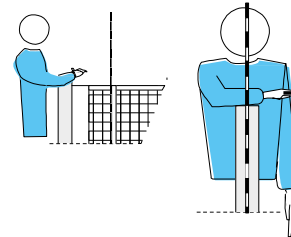
**DIAGRAM 11 (D11): REFEREES' OFFICIAL HAND SIGNALS (CONTINUED)**

- Legend:      ① ② Referee(s) who must show the signal according to their regular responsibilities  
                  ① ② Referee(s) who show the signal in special situations

**20 REACHING BEYOND THE NET**

*Relevant Rules: 11.4.1, 13.3.1, 14.3, 14.6.1, 23.3.2.3c*

Place a hand above the net, palm facing downwards



①

**21 ATTACK HIT FAULT**

*Relevant Rules:*

- *by a back-row player or by a libero*  
13.3.3, 13.3.4, 13.3.5, 23.3.2.3d/e, 24.3.2.4
- *on an overhead finger pass by the Libero in his/her front zone or its extension:*  
13.3.6

Make a downward motion with the forearm, hand open

① ②



**22 PENETRATION INTO THE OPPONENT COURT or  
 BALL CROSSING THE LOWER SPACE or  
 THE SERVER TOUCHES THE COURT (END LINE) WITH HIS/HER BUTTOCKS or  
 THE PLAYER SITS OUTSIDE HIS/HER COURT AT THE MOMENT OF THE SERVICE HIT**

*Relevant Rules: 8.4.5, 11.2.2, 12.4.3, 23.3.2.3a/f, 24.3.2.1*

Point to the center line or to the relevant line

① ②



**DIAGRAM 11 (D11): REFEREES' OFFICIAL HAND SIGNALS (CONTINUED)**

Legend:      ① ② Referee(s) who must show the signal according to their regular responsibilities  
                  ① ② Referee(s) who show the signal in special situations

**23 DOUBLE FAULT AND REPLAY**

*Relevant Rules: 6.1.2.2, 9.1.2.3, 17.2, 22.2.3.4*

Raise both thumbs vertically

①



**24 BALL TOUCHED**

*Relevant Rules: 23.3.2.3b, 24.2.2*

Brush the palm of one hand with the fingers of the other, held vertically

①

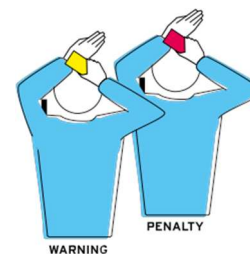


**25 DELAY WARNING / DELAY PENALTY**

*Relevant Rules: 15.11.3, 16.2.2, 23.3.2.2*

Cover the wrist with a YELLOW card (warning) or with a RED card (penalty)

①



**26 LIFTING**

*Relevant Rules: 9.3.5, 9.4.1, 9.4.2, 23.3.2.3b, 24.3.2.8*

Hold the hands horizontally, palms together and raise the upper palm from the lower palm

① ②

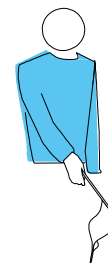


**DIAGRAM 12 (D12): LINE JUDGES' OFFICIAL FLAG SIGNALS**

**1 BALL IN**

*Relevant Rules: 8.3, 29.2.1.1*

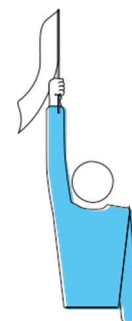
Point down with the flag



**2 BALL OUT**

*Relevant Rules: 8.4.1, 29.2.1.1*

Raise the flag vertically



**3 BALL TOUCHED**

*Relevant Rule: 29.2.1.2*

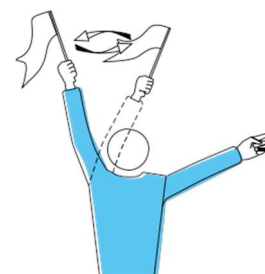
Raise the flag and touch the top with the palm of the free hand



**4 CROSSING SPACE FAULTS, BALL TOUCHED BY AN OUTSIDE OBJECT, OR FOOT FAULT BY ANY PLAYER DURING SERVICE**

*Relevant Rules: 8.4.2, 8.4.3, 8.4.4, 12.4.3, 29.2.1.3, 29.2.1.4, 29.2.1.6, 29.2.1.7*

Wave flag over the head and point to the antenna or the respective line



**DIAGRAM 12 (D12): LINE JUDGES' OFFICIAL FLAG SIGNALS (CONTINUED)**

**5 JUDGEMENT IMPOSSIBLE**

Raise and cross both arms and hands in front of the chest





PART 3  
**DEFINITIONS**

DEFINITIONS	
WORD	DEFINED AS
Areas	These are the sections of the floor OUTSIDE the free zone, identified by the rules as having a specific function. This includes the warm-up area.
Ball Retrievers	These are the personnel whose job it is to maintain the flow of the game by rolling the ball to the server between rallies.
Competition Control Area	The Competition Control Area is a corridor around the playing court and free zone, which includes all spaces up to the outer barriers or delimitation fence. See Diagram 1a.
Crossing Space	The crossing space is defined by: <ul style="list-style-type: none"> <li>- The horizontal band at the top of the net</li> <li>- The antennae and their extension</li> <li>- The ceiling</li> </ul> The ball must cross to the opponent's COURT through the crossing space.
Dribbling	Dribbling means bouncing the ball (usually as a preparation to tossing and serving). Other preparatory actions could include (amongst others) moving the ball from hand to hand.
External Space	The external space is the vertical plane of the net outside of the crossing and lower spaces.
Fault	a) A playing action contrary to the Rules. b) A Rule violation other than a playing action.
Interference	Any action which will create an advantage against the opponent team or any action which prevents an opponent from playing the ball.
Interval	The time between sets. The change of courts in the deciding (5 <sup>th</sup> ) set is not to be regarded as an interval.
Knee Up	Kneeing up is a natural movement during a defensive action should be allowed - but moving in any direction on the knees (and losing contact with the floor between buttocks and shoulders) to reach the ball is a fault. Kneeing up during an attack hit is a fault.
Lower Space	This is the space defined at its upper part by the bottom of the net and the cord joining it to the posts, at the sides by the posts, and at the bottom by the playing surface.
Moppers	These are the personnel whose job it is to keep the floor clean and dry. They mop the court before the match, between the sets and, if necessary, after each rally.
Outside Object	An object or a person which while outside the playing court or close to the limit of the free playing space provides an obstruction to the flight of the ball. For example, overhead lights, the referee's chair, TV equipment, scorer's table, and net posts. Outside objects do not include the antennae since they are considered as part of the net.

DEFINITIONS	
WORD	DEFINED AS
Raise the Body	In Rule 12.6.1 - Faults made during service - Rule 12.6.1.3 – lifts his/her buttocks. Referees must be able to tell the difference between a “slight” / natural lifting movement during service, which should be allowed, as opposed to an intentional lift, which is a “fault”.  During movement on to the court after service, the player may raise the body or knee up shortly, as at this moment as he/she is not in action of playing the ball, provided that player does not gain an advantage by “Taking Steps”.
Rally Point	This is the system of scoring a point whenever a rally is won.
Re-designation	This is the act by which a Libero, who cannot continue or is declared by the team unable to play, has his/her role taken by any other player (except the regular replacement player) not on the court at the moment of the re-designation
Replacement	This is the act by which a regular player leaves the court and either Libero (if more than one) takes his/her place. This can even include Libero for Libero exchanges. The regular player can then replace either Libero. There must be a completed rally between replacements involving any Libero.
Substitution	This is the act by which one regular player leaves the court and another regular player takes his/her place.
Substitution Zone	This is the part of the free zone through which substitutions are carried out.
Taking Steps	Means that the player has made a clear effort to either stand up on their stumps or to “crab walk” using hands and feet to establish a new position to play the ball, such as moving to position after the service or to moving to reach a ball that is some distance from the player. To stand up or take steps is a fault.
Unless by Agreement with World ParaVolley	This statement recognizes that while there are regulations on the standards and specification of equipment and facilities, there are occasions when special arrangements can be made by World ParaVolley in order to promote the game of Volleyball or to test new conditions.
World ParaVolley Standards	The technical specifications or limits as defined by World ParaVolley to the manufacturers of equipment.
Zones	These are sections within the playing area (i.e. playing court and free zone) as defined for a specific purpose (or with special restrictions) within the Rule text. These include: Front Zone, Service Zone, Substitution Zone, Free Zone, Back Zone and Libero Replacement Zone.





**MEMO**

A series of horizontal dashed lines for writing.



[worldparavolley.org](http://worldparavolley.org)